

Pioneer *sound.vision.soul*

**AUDIO/VIDEO MULTI-CHANNEL
RECEIVER**

VSX-416-S/-K

VSX-516-S/-K

Operating Instructions

IMPORTANT



The lightning flash with arrowhead symbol, within an equilateral triangle, is intended to alert the user to the presence of uninsulated "dangerous voltage" within the product's enclosure that may be of sufficient magnitude to constitute a risk of electric shock to persons.

CAUTION

**RISK OF ELECTRIC SHOCK
DO NOT OPEN**



CAUTION:
TO PREVENT THE RISK OF ELECTRIC SHOCK, DO NOT REMOVE COVER (OR BACK). NO USER-SERVICEABLE PARTS INSIDE. REFER SERVICING TO QUALIFIED SERVICE PERSONNEL.

The exclamation point within an equilateral triangle is intended to alert the user to the presence of important operating and maintenance (servicing) instructions in the literature accompanying the appliance.

D3-4-2-1-1_En-A

NOTE: This equipment has been tested and found to comply with the limits for a Class B digital device, pursuant to Part 15 of the FCC Rules. These limits are designed to provide reasonable protection against harmful interference in a residential installation. This equipment generates, uses, and can radiate radio frequency energy and, if not installed and used in accordance with the instructions, may cause harmful interference to radio communications. However, there is no guarantee that interference will not occur in a particular installation. If this equipment does cause harmful interference to radio or television reception, which can be determined by turning the equipment off and on, the user is encouraged to try to correct the interference by one or more of the following measures:

- Reorient or relocate the receiving antenna.
- Increase the separation between the equipment and receiver.
- Connect the equipment into an outlet on a circuit different from that to which the receiver is connected.
- Consult the dealer or an experienced radio/TV technician for help.

D8-10-1-2_En

Information to User

Alteration or modifications carried out without appropriate authorization may invalidate the user's right to operate the equipment.

D8-10-2_En

CAUTION: This product satisfies FCC regulations when shielded cables and connectors are used to connect the unit to other equipment. To prevent electromagnetic interference with electric appliances such as radios and televisions, use shielded cables and connectors for connections.

D8-10-3a_En

Replacement and mounting of an AC plug on the power supply cord of this unit should be performed only by qualified service personnel.

IMPORTANT: THE MOULDED PLUG

This appliance is supplied with a moulded three pin mains plug for your safety and convenience. A 10 amp fuse is fitted in this plug. Should the fuse need to be replaced, please ensure that the replacement fuse has a rating of 10 amps and that it is approved by ASTA or BSI to BS1362.

Check for the ASTA mark  or the BSI mark  on the body of the fuse.

If the plug contains a removable fuse cover, you must ensure that it is refitted when the fuse is replaced. If you lose the fuse cover the plug must not be used until a replacement cover is obtained. A replacement fuse cover can be obtained from your local dealer.

If the fitted moulded plug is unsuitable for your socket outlet, then the fuse shall be removed and the plug cut off and disposed of safely. There is a danger of severe electrical shock if the cut off plug is inserted into any 13 amp socket.

If a new plug is to be fitted, please observe the wiring code as shown below. If in any doubt, please consult a qualified electrician.

IMPORTANT: The wires in this mains lead are coloured in accordance with the following code:

Blue : Neutral Brown : Live

As the colours of the wires in the mains lead of this appliance may not correspond with the coloured markings identifying the terminals in your plug, proceed as follows ;

The wire which is coloured BLUE must be connected to the terminal which is marked with the letter **N** or coloured BLACK.

The wire which is coloured BROWN must be connected to the terminal which is marked with the letter **L** or coloured RED.

How to replace the fuse: Open the fuse compartment with a screwdriver and replace the fuse.

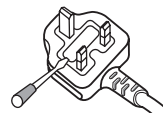

D3-4-2-1-2-2_B_En

Voltage selector

You can find the voltage selector switch on the rear panel of multi-voltage models.

The factory setting for the voltage selector is 220 V. Please set it to the correct voltage for your country or region.

- Saudi Arabia operates on 127 V and 220 V mains voltage. Please set to the correct voltage before using.
- For Taiwan, please set to 110 V before using.
- For Mexico, please set to 120 V to 127 V before using.

Before changing the voltage, disconnect the AC power cord. Use a medium size screwdriver to change the voltage selector switch.

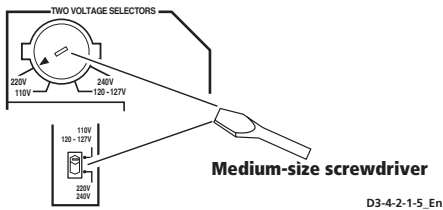

For Taiwan exclusively

Taiwanese two pin flat-bladed plug

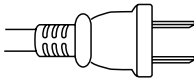

VENTILATION CAUTION

When installing this unit, make sure to leave space around the unit for ventilation to improve heat radiation (at least 40 cm at top, 10 cm at rear, and 20 cm at each side).

WARNING

Slots and openings in the cabinet are provided for ventilation to ensure reliable operation of the product, and to protect it from overheating. To prevent fire hazard, the openings should never be blocked or covered with items (such as newspapers, table-cloths, curtains) or by operating the equipment on thick carpet or a bed. D3-4-2-1-7b_A_En

WARNING

This equipment is not waterproof. To prevent a fire or shock hazard, do not place any container filled with liquid near this equipment (such as a vase or flower pot) or expose it to dripping, splashing, rain or moisture. D3-4-2-1-3_A_En

WARNING

To prevent a fire hazard, do not place any naked flame sources (such as a lighted candle) on the equipment. D3-4-2-1-7a_A_En

WARNING

Before plugging in for the first time, read the following section carefully.

The voltage of the available power supply differs according to country or region. Be sure that the power supply voltage of the area where this unit will be used meets the required voltage (e.g., 230 V or 120 V) written on the rear panel. D3-4-2-1-4_A_En

CAUTION

The STANDBY/ON switch on this unit will not completely shut off all power from the AC outlet. Since the power cord serves as the main disconnect device for the unit, you will need to unplug it from the AC outlet to shut down all power. Therefore, make sure the unit has been installed so that the power cord can be easily unplugged from the AC outlet in case of an accident. To avoid fire hazard, the power cord should also be unplugged from the AC outlet when left unused for a long period of time (for example, when on vacation).

If the AC plug of this unit does not match the AC outlet you want to use, the plug must be removed and appropriate one fitted. Replacement and mounting of an AC plug on the power supply cord of this unit should be performed only by qualified service personnel. If connected to an AC outlet, the cut-off plug can cause severe electrical shock. Make sure it is properly disposed of after removal. The equipment should be disconnected by removing the mains plug from the wall socket when left unused for a long period of time (for example, when on vacation). D3-4-2-2-1a_A_En

Operating Environment

Operating environment temperature and humidity: +5 °C to +35 °C (+41 °F to +95 °F); less than 85 %RH (cooling vents not blocked)

Do not install this unit in a poorly ventilated area, or in locations exposed to high humidity or direct sunlight (or strong artificial light) D3-4-2-1-7c_A_En

This product is for general household purposes. Any failure due to use for other than household purposes (such as long-term use for business purposes in a restaurant or use in a car or ship) and which requires repair will be charged for even during the warranty period. K041_En

Contents

01 Before you start

Checking what's in the box	5
Loading the batteries	5
Operating range of remote control unit	5
Installing the receiver	6

02 5 minute guide

Introduction to home theater	7
Listening to Surround Sound	7
Using the Quick Setup	8

03 Quick surround sound setup

Automatically setting up for surround sound (MCACC)	9
Other problems during Auto MCACC	10

04 Connecting up

Making cable connections	11
Analog audio cables	11
Digital audio cables	11
Video cables	11
Connecting a TV and DVD player	12
Connecting the multichannel analog outputs	13
Connecting a satellite receiver or other digital set-top box	13
Connecting other audio components	14
About the WMA9 Pro decoder	14
Connecting other video components	15
Connecting antennas	16
Using external antennas	16
Connecting the speakers	17
Speaker terminals	18
Hints on speaker placement	18
Speaker placement diagrams	19

05 Controls and displays

Front panel	20
Display	21
Remote control (VSX-516)	23
Remote control (VSX-416)	26

06 Listening to your system

Auto playback	28
Listening in surround sound	28
Using the Advanced surround effects	29
Setting the effect options	29
Listening in stereo	30
Listening with Acoustic Calibration EQ	30
Choosing the input signal	31

Using surround back channel processing	31
Using Virtual Surround Back (VSB)	32
Using Midnight and Loudness	33
Enhancing dialog	33
Using the tone controls	33
Using the Sound Retriever	33
Playing other sources	33
Selecting the multichannel analog inputs	33

07 The System Setup menu

Using the System Setup menu	34
Manual MCACC speaker setup	34
Fine Channel Level	35
Fine Speaker Distance	35
Acoustic Calibration EQ	36
Manual speaker setup	38
Speaker setting	38
Crossover network	39
Channel level	39
Speaker Distance	39
The Input Assign menu	39
The Other setup menu	40
Dynamic Range Control Setup	40
Dual Mono Setup	40
LFE Attenuator Setup	40

08 Using the tuner

Listening to the radio	41
Tuning directly to a station	41
Saving station presets	41
Naming station presets	41
Listening to station presets	42
Changing the frequency step	42

09 Making recordings

Making an audio or a video recording	43
--	----

10 Controlling the rest of your system

Setting the remote to control other components	44
Selecting preset codes directly	44
Direct function	45
Clearing all the remote control settings	45
Controls for TVs	46
Controls for other components	47
Preset Code List	49

11 Additional information

Troubleshooting	50
Resetting the main unit	52
Switching the speaker impedance	52
Power cord caution	52
Specifications	53
Cleaning the unit	54

Chapter 1: Before you start

Checking what's in the box

Please check that you've received the following supplied accessories:

- AM loop antenna
- FM wire antenna
- AA size IEC R6 dry cell batteries (to confirm system operation) x2
- Remote control
- Setup microphone (*VSX-516 model only*)
- Power cords (make sure you use the correct cord for your country/region):
VSX-416/516-K (black models)
Round 2-pin type and Australian type
VSX-416/516-S (silver models)
Round 2-pin type, flat blade 2-pin type and UK 3-pin type (Except Australian model)
- Power plug adaptor (*VSX-416/516-K only*)
- J-shaped plug
- These operating instructions

Loading the batteries

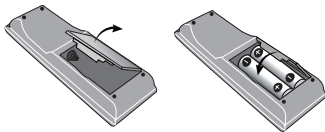

Illustration shows the VSX-416 model

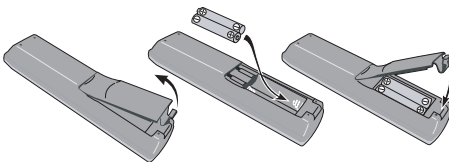

Illustration shows the VSX-516 model

Important

Incorrect use of batteries may result in such hazards as leakage and bursting. Observe the following precautions:

- Never use new and old batteries together.
- Insert the plus and minus sides of the batteries properly according to the marks in the battery case.
- Batteries with the same shape may have different voltages. Do not use different batteries together.
- When disposing of used batteries, please comply with governmental regulations or environmental public instruction's rules that apply in your country/area.

WARNING

- Do not use or store batteries in direct sunlight or other excessively hot place, such as inside a car or near a heater. This can cause batteries to leak, overheat, explode or catch fire. It can also reduce the life or performance of batteries.

Operating range of remote control unit

The remote control has a range of about 7 meters. It may not work properly if:

- There are obstacles between the remote control and the receiver's remote sensor.
- Direct sunlight or fluorescent light is shining onto the remote sensor.
- The receiver is located near a device that is emitting infrared rays.
- The receiver is operated simultaneously with another infrared remote control unit.

Installing the receiver

- When installing this unit, make sure to put it on a level and stable surface.

Don't install it on the following places:

- on a color TV (the screen may distort)
- near a cassette deck (or close to a device that gives off a magnetic field). This may interfere with the sound.
- in direct sunlight
- in damp or wet areas
- in extremely hot or cold areas
- in places where there is vibration or other movement
- in places that are very dusty
- in places that have hot fumes or oils (such as a kitchen)

Chapter 2: 5 minute guide

Introduction to home theater

Home theater refers to the use of multiple audio tracks to create a surround sound effect, making you feel like you're in the middle of the action or concert. The surround sound you get from a home theater system depends not only on your speaker setup, but also on the source and the sound settings of the receiver.

This receiver will automatically decode multichannel Dolby Digital, DTS, or Dolby Surround sources according to your speaker setup. In most cases, you won't have to make changes for realistic surround sound, but other possibilities (like listening to a CD with multichannel surround sound) are explained in *Listening to your system* on page 28.

Listening to Surround Sound

This receiver was designed with the easiest possible setup in mind, so with the following quick setup guide, you should have your system hooked up for surround sound in no time at all. In most cases, you can simply leave the receiver in the default settings.

- Be sure to complete all connections before connecting to an AC power source.

1 Connect your TV and DVD player.

See *Connecting a TV and DVD player* on page 12 to do this. For surround sound, you'll want to hook up using a digital connection from the DVD player to the receiver.

2 Connect your speakers and place them for optimal surround sound.

See *Connecting the speakers* on page 17.

Note

¹ Depending on your DVD player or source discs, you may only get digital 2 channel stereo and analog sound. In this case, the listening mode must be set to **STANDARD** (it should already be set—see *Listening in surround sound* on page 28 if you need to do this) if you want multichannel surround sound.

Where you place the speakers will have a big effect on the sound. Place your speakers as shown below for the best surround sound effect. Also see *Hints on speaker placement* on page 18 for more on this.

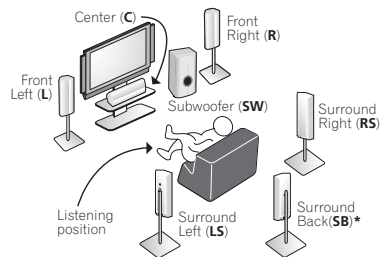

* VSX-516 model only

3 Plug in and switch on the receiver, followed by your DVD player, subwoofer and TV.

Make sure you've set the video input on your TV to this receiver. Check the manual that came with the TV if you don't know how to do this.

4 Press QUICK SETUP on the front panel to specify your speaker setup, room size and listening position.

Use the **MULTI JOG** dial to select and **ENTER** to confirm your selection. See *Using the Quick Setup* below for more on this.

5 Play a DVD, and adjust the volume.

Make sure that **DVD/LD** is showing in the receiver's display, indicating that the DVD input is selected. If it isn't, press **DVD** (VSX-416 model) / **DVD/LD** (VSX-516 model) on the remote to set the receiver to the DVD input.

There are several other sound options you can select. See *Listening to your system* on page 28 for more on this.¹ See also *The System Setup menu* on page 34 for more setup options.

Using the Quick Setup

You can use the Quick Setup to get your system up and running with just a few button presses. The receiver automatically makes the necessary settings after you have selected your speaker setup, room size and listening position.

- *VSX-516 model only* – For a more complete surround setup, see *Automatically setting up for surround sound (MCACC)* on page 9.

If you want to make more specific settings, refer to *The System Setup menu* on page 34.

Use the front panel controls for the steps below.

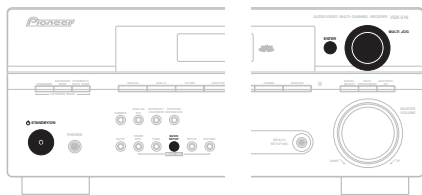

Illustration shows the VSX-516 model

- 1 If the receiver is off, press **STANDBY/ON** to turn the power on.
- 2 Press **QUICK SETUP**.
- 3 Confirm your subwoofer setting.
 - *VSX-416 model* – Use the **MULTI JOG** dial to select **SW YES** or **SW NO**, depending on whether you've connected a subwoofer, then press **ENTER**.
 - *VSX-516 model* – **SW DET** flashes in the display while the receiver checks your setup for a subwoofer. **SW YES** or **SW NO** confirms the subwoofer check, then the display prompts you to select your speaker setup.
- 4 Use the **MULTI JOG** dial to choose your speaker setup.

If you selected **SW YES** (*VSX-416 model*) or subwoofer was detected (*VSX-516 model*) for the subwoofer setting in step 3, the following choices are available:

2.1ch – 3.1ch – 4.1ch – 5.1ch – 6.1ch*

If you selected **SW NO** (*VSX-416 model*) or subwoofer wasn't detected (*VSX-516 model*) for the subwoofer setting in step 3, the following choices are available:

2.0ch – 3.0ch – 4.0ch – 5.0ch – 6.0ch*

- Check the table below to find the speaker setup that corresponds with your system.

	Front Speakers	Center Speaker	Surround Speakers	Surround Back Sp.	Sub Woofer
2.0 ch	✓				
2.1 ch	✓				✓
3.0 ch	✓	✓			
3.1 ch	✓	✓			✓
4.0 ch	✓		✓		
4.1 ch	✓		✓		✓
5.0 ch	✓	✓	✓		
5.1 ch	✓	✓	✓		✓
6.0 ch*	✓	✓	✓	✓	
6.1 ch*	✓	✓	✓	✓	✓

* *VSX-516 model only*

5 Press **ENTER**.

6 Use the **MULTI JOG** dial to choose your room size.

Depending on the distance of your speakers from the listening position, choose between small, medium, or large (**S**, **M** or **L**), **M** being an average-sized room.

7 Press **ENTER**.

8 Use the **MULTI JOG** dial to choose your listening position.

You can cycle between the following choices:

- **FWD** – If you are nearer to the front speakers than the surround speakers
- **MID** – If you are equal distance from the front and surround speakers
- **BACK** – If you are nearer to the surround speakers than the front speakers

9 Press **ENTER** to confirm your setup.

The display shows the speaker setup, room size and listening position that you have selected.

Chapter 3:

Quick surround sound setup

VSX-516 model only

Automatically setting up for surround sound (MCACC)

The Auto Multi-Channel Acoustic Calibration (MCACC) setup measures the acoustic characteristics of your listening area, taking into account ambient noise, speaker size and distance, and tests for both channel delay and channel level. After you have set up the microphone provided with your system, the receiver uses the information from a series of test tones to optimize the speaker settings and equalization for your particular room.

**Important**

- The Auto MCACC Setup will overwrite any existing speaker settings you've made.
- Make sure the headphones are unplugged.

**Caution**

- The test tones used in the Auto MCACC Setup are output at high volume.

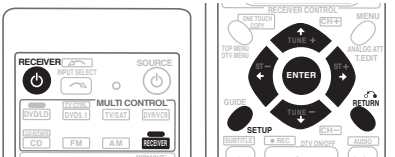

1 Connect the microphone to the MCACC SETUP MIC jack on the front panel.

Make sure there are no obstacles between the speakers and the microphone.

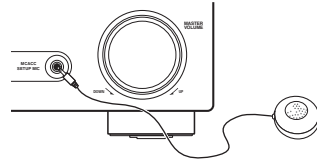

If you have a tripod, use it to place the microphone so that it's about ear level at your normal listening position. Otherwise, place the microphone at ear level using a table or a chair.

2 If the receiver is off, press  RECEIVER to turn the power on.

3 If you have a subwoofer, turn it on.

4 Press RECEIVER on the remote control, then press the SETUP button.

- Press **SETUP** again at any time to exit the System Setup menu.¹

5 Select 'A. MCACC' from the System Setup menu then press ENTER.

Try to be as quiet as possible after pressing **ENTER**. The system outputs a series of test tones to establish the ambient noise level.

If the noise level is too high, **NOISY!** blinks in the display for five seconds. To exit and check the noise levels again, press **SETUP** (see the notes about ambient noise below) or press **ENTER** when you're prompted to **RETRY?**

- Do not adjust the volume during the test tones. This may result in incorrect speaker settings.

The system now checks the microphone and your speaker setup.

 **Note**

¹ The receiver will automatically exit the current menu after three minutes of inactivity. If you cancel the Auto MCACC Setup at any time, the receiver automatically exits and no settings will be made.

If you see an **ERR** message in the display, there may be a problem with your mic or the speaker connections. Turn off the power, and check the problem indicated by the **ERR** message (see below), then try the auto surround setup again.

- **ERR MIC** – Check microphone connection.
- **ERR Fch** – Check front speaker connections.
- **ERR Sch** – Check surround speaker connections.
- **ERR SBch** – Check surround back speaker connection.
- **ERR SW** – Make sure the subwoofer has been switched on and volume on the subwoofer is turned up.

6 When you see CHECK OK in the display, confirm your speaker configuration.

Use **↑/↓** (cursor up/down) to check each speaker in turn. **YES** or **NO** should reflect the actual speakers connected. If the speaker configuration displayed isn't correct, use **←/→** (cursor left/right) to change the setting. When you're finished, go to the next step.

7 Select CHECK OK in the display then press ENTER.

The Auto MCACC checks the subwoofer level.

- If the subwoofer output level is too high/low, **SW.VOL.DOWN/SW.VOL.UP** blinks in the display for five seconds. To exit and check your subwoofer output level, press **SETUP** or simply press **ENTER** when you're prompted to **RETRY?**

The receiver outputs more test tones to determine the optimum receiver settings for speaker setting, channel level, speaker distance, and Acoustic Calibration EQ.

8 The Auto MCACC Setup has finished!

The front panel MCACC indicator lights to show the surround settings are complete.

The settings made in the Auto MCACC Setup should give you excellent surround sound from your system, but it is also possible to adjust these settings manually using the System Setup menu (starting on page 34).¹

Optionally, when you see **SKIP?** you can press **↑/↓** (cursor up/down) to select one of the following options then press **ENTER**, and use **↑/↓** (cursor up/down) to check the settings:

- **CHK SP** – Check the size and number of speakers you've connected (see page 38 for more on this)
- **CHK DIST.** – Check the distance of your speakers from the listening position (see page 39 for more on this)
- **CHK LEVEL** – Check the overall balance of your speaker system (see page 39 for more on this)
- **CHK EQ** – Select either **ALL CH** or **F ALIGN** to check the adjustments to the frequency balance of your speaker system based on the acoustic characteristics of your room (see page 36 for more on this)

9 When you're finished, select 'SKIP?' to go back to the System Setup menu.

- Remember to disconnect the microphone after completing the Auto MCACC Setup.

Other problems during Auto MCACC

If the room environment is not optimal for the Auto MCACC Setup (too much background noise, echo off the walls, obstacles blocking the speakers from the microphone) the final settings may be incorrect. Check for household appliances (air conditioner, fridge, fan, etc.), that may be affecting the environment and switch them off if necessary.² If there are any instructions showing in the front panel display, please follow them.

Note

¹ • Depending on the characteristics of your room, sometimes identical speakers with cone sizes of around 12cm will end up with different size settings. You can correct the setting manually using the *Speaker setting* on page 38.

• The subwoofer distance setting may be farther than the actual distance from the listening position. This setting should be accurate (taking delay and room characteristics into account) and generally does not need to be changed.

² Some older TVs may interfere with operation of the mic. You may want to switch off your TV during the Auto MCACC Setup.

Chapter 4: Connecting up

Making cable connections

Make sure not to bend the cables over the top of this unit (as shown in the illustration). If this happens, the magnetic field produced by the transformers in this unit may cause a humming noise from the speakers.

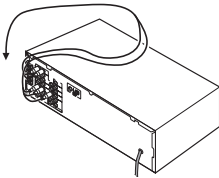

Important

- Before making or changing any connections, switch off the power and disconnect the power cord from the AC outlet.
- Before unplugging the power cord, switch the power into standby.

Analog audio cables

Use stereo RCA phono cables to connect analog audio components. These cables are typically red and white, and you should connect the red plugs to R (right) terminals and white plugs to L (left) terminals.

Analog audio cables

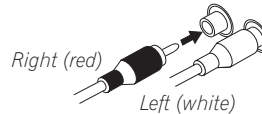

Digital audio cables

Commercially available coaxial digital audio cables or optical cables should be used to connect digital components to this receiver.¹

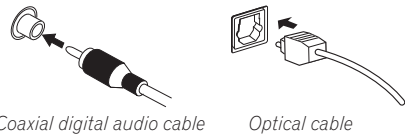

Video cables

Standard RCA video cables

These cables are the most common type of video connection and should be used to connect to the composite video terminals. They have yellow plugs to distinguish them from cables for audio.

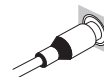

Standard RCA video cable

Note

- When connecting optical cables, be careful when inserting the plug not to damage the shutter protecting the optical socket.
- When storing optical cable, coil loosely. The cable may be damaged if bent around sharp corners.
- You can also use a standard RCA video cable for coaxial digital connections.

Connecting a TV and DVD player

This page shows you how to connect your DVD player and TV to the receiver.

1 Connect a coaxial digital audio output on your DVD player to the DIGITAL COAX 1 (DVD/LD) input on this receiver.

Use a coaxial digital audio cable for the connection.¹

2 Connect the composite video output and the stereo analog audio outputs² on your DVD player to the DVD/LD inputs on this receiver.

Use a standard RCA video cable and a stereo RCA phono cable for the connection.

- If your DVD player has multichannel analog outputs, see *Connecting the multichannel analog outputs* below for how to connect it.

3 Connect the analog audio outputs from your TV to the TV/SAT inputs on this receiver.

This will allow you to play the sound from the TV's built-in tuner. Use a stereo RCA phono cable to do this.

- If your TV has a built-in digital decoder, you can also connect an optical digital audio output from your TV to the **DIGITAL OPT 1 (CD)** input on this receiver. Use an optical cable for the connection.³

4 Connect the MONITOR OUT video jack on this receiver to a video input on your TV.

Use a standard RCA video cable to connect to the composite video jack.

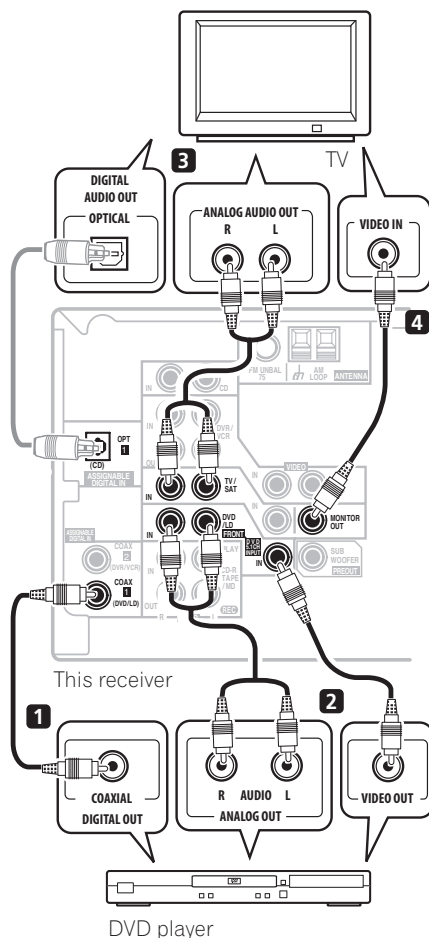

Note

¹ If your DVD player only has an optical digital output, you can connect it to the optical input on this receiver using an optical cable. When you set up the receiver you'll need to tell the receiver which input you connected the player to (see *The Input Assign menu* on page 39).

² This connection will allow you to make analog recordings from your DVD player.

³ In this case, you'll need to tell the receiver which digital input you connected the TV to (see *The Input Assign menu* on page 39).

Connecting up

Connecting the multichannel analog outputs

For DVD Audio and SACD playback, your DVD player may have 5.1 channel analog outputs. In this case, you can connect them to the multi-channel inputs of the receiver as shown below.¹

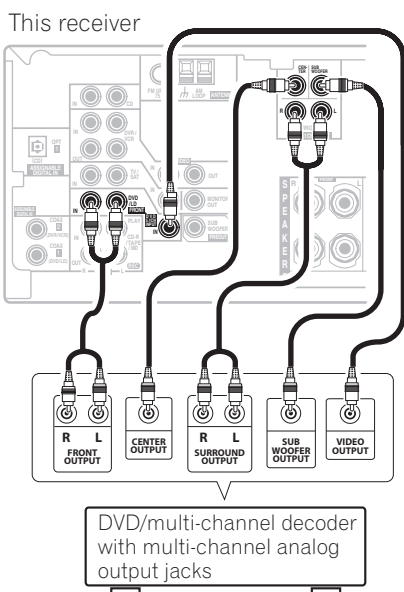

Connecting a satellite receiver or other digital set-top box

Satellite and cable receivers, and terrestrial digital TV tuners are all examples of so-called 'set-top boxes'.

1 Connect a set of audio/video outputs on the set-top box component to the TV/SAT AUDIO and VIDEO inputs on this receiver.²

Use a stereo RCA phono cable for the audio connection and a standard RCA video cable for the video connection.

2 If your set-top box has a digital output, connect it to a digital input on this receiver.

The example shows an optical connection to the **DIGITAL OPT 1 (CD)** input.³

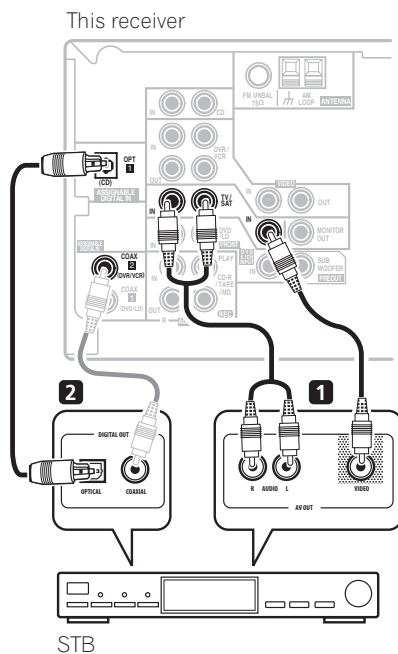

Note

¹ The multichannel input can only be used when **DVD 5.1 ch** is selected (see page 33).

² If you've already connected your TV to the TV/SAT inputs, simply choose another input. However, you'll need to remember which input you connected the set-top box to.

³ In this case, you'll need to tell the receiver which digital input you connected the set-top box to (see *The Input Assign menu* on page 39).

Connecting other audio components

The number and kind of connections depends on the kind of component you're connecting.¹ Follow the steps below to connect a CD-R, MD, DAT, tape recorder or other audio component.

1 If your component has a digital output, connect this to a digital input on the receiver.

The example shows an optical connection to the **DIGITAL OPT 1 (CD)** input.

2 If necessary, connect the analog audio outputs of the component to a set of spare audio inputs on this receiver.

You'll need to make this connection for components without a digital output, or if you want to record from a digital component. Use a stereo RCA phono cable as shown.

3 If you're connecting a recorder, connect the analog audio outputs (REC) to the analog audio inputs on the recorder.

The example shows an analog connection to the **CD-R/TAPE/MD** analog output jack using a stereo RCA phono cable.

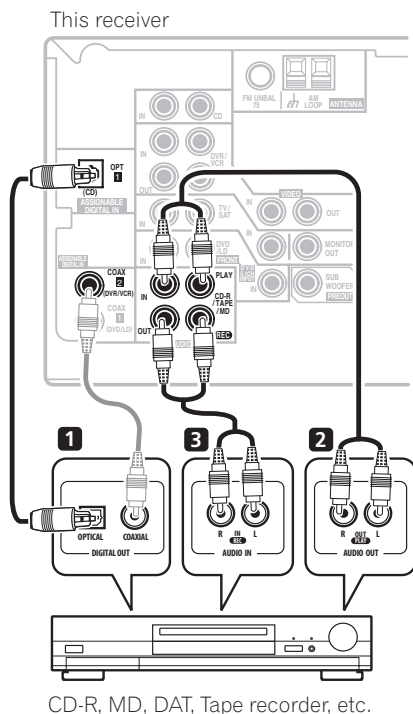

About the WMA9 Pro decoder

This unit has an on-board Windows Media[®] Audio 9 Professional (WMA9 Pro) decoder, so it is possible to playback WMA9 Pro-encoded audio using a coaxial or optical digital connection when connected to a WMA9 Pro-compatible player. However, the connected DVD player, set-top box, etc. must be able to output WMA9 Pro format audio signals through a coaxial or optical digital output.



Note

¹ Note that you must connect digital components to analog audio jacks if you want to record to/from digital components (like an MD) to/from analog components.

Microsoft, Windows Media[®], and the Windows logo are trademarks, or registered trademarks of Microsoft Corporation in the United States and/or other countries.

Connecting other video components

This receiver has audio/video inputs and outputs suitable for connecting analog or digital video recorders, including VCRs, DVD-recorders and HDD recorders.

1 Connect a set of audio/video outputs on the recorder to the DVR/VCR AUDIO and VIDEO inputs on this receiver.

Use a stereo RCA phono cable for the audio connection and a standard RCA video cable for the video connection.

2 Connect a set of audio/video inputs on the recorder to the DVR/VCR AUDIO and VIDEO outputs on this receiver.

Use a stereo RCA phono cable for the audio connection and a standard RCA video cable for the video connection.

3 If your video component has a digital audio output, connect it to a digital input on this receiver.

The example shows a recorder connected to the **DIGITAL COAX 2 (DVR/VCR)** input.¹

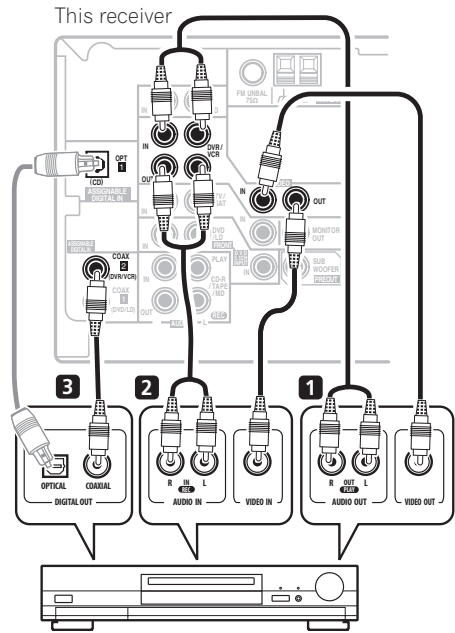

DVR, VCR, LD player, etc.

Note

¹ If your video component doesn't have a digital audio output, omit this step. If it only has an optical digital output, you can connect it to the optical input on this receiver using an optical cable. When you set up the receiver you'll need to tell the receiver which input you connected the component to (see *The Input Assign menu* on page 39).

Connecting antennas

Connect the AM loop antenna and the FM wire antenna as shown below. To improve reception and sound quality, connect external antennas (see *Using external antennas* below).

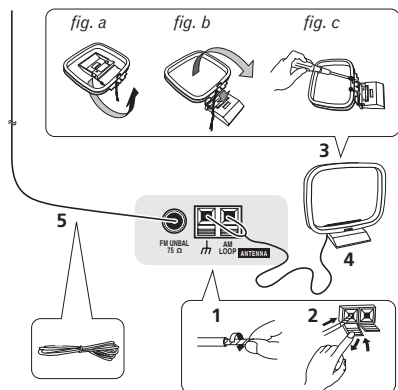

1 Pull off the protective shields of both AM antenna wires.

2 Push open the tabs, then insert one wire fully into each terminal, then release the tabs to secure the AM antenna wires.

3 Fix the AM loop antenna to the attached stand.

To fix the stand to the antenna, bend in the direction indicated by the arrow (*fig. a*) then clip the loop onto the stand (*fig. b*).

- If you plan to mount the AM antenna to a wall or other surface, secure the stand with screws (*fig. c*) before clipping the loop to the stand. Make sure the reception is clear.

4 Place the AM antenna on a flat surface and in a direction giving the best reception.

5 Connect the FM wire antenna in the same way as the AM loop antenna.

For best results, extend the FM antenna fully and fix to a wall or door frame. Don't drape loosely or leave coiled up.

Using external antennas

To improve FM reception

Connect an external FM antenna as shown below.

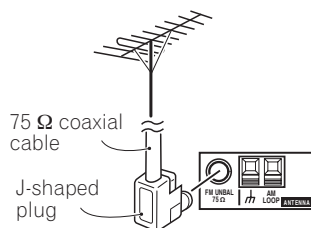

To improve AM reception

Connect a 5 to 6 meter length of vinyl-coated wire to the AM antenna terminal without disconnecting the supplied AM loop antenna.

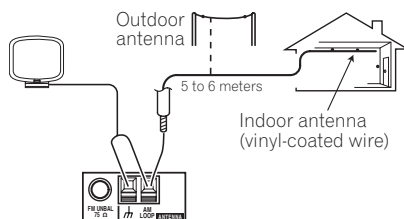

For the best possible reception, suspend horizontally outdoors.

Connecting the speakers

A complete speaker setup is shown below, but everyone's home setup will vary. Simply connect the speakers you have in the manner illustrated. The receiver will work with just two stereo speakers (the front speakers in the diagram) but using at least three speakers (*VSX-416 model*) / four speakers (*VSX-516 model*) is recommended, and a complete setup is best for surround sound. If you're not using a subwoofer, change the front speaker setting (see *Speaker setting* on page 38) to **LARGE**.

Make sure you connect the speaker on the right to the right terminal and the speaker on the left to the left terminal. Also make sure the positive and negative (+/-) terminals on the receiver match those on the speakers. You can use speakers with a nominal impedance between 6 Ω to 16 Ω (please see *Switching the speaker impedance* on page 52 if you plan to use speakers with an impedance of less than 8 Ω).

Be sure to complete all connections before connecting this unit to the AC power source.

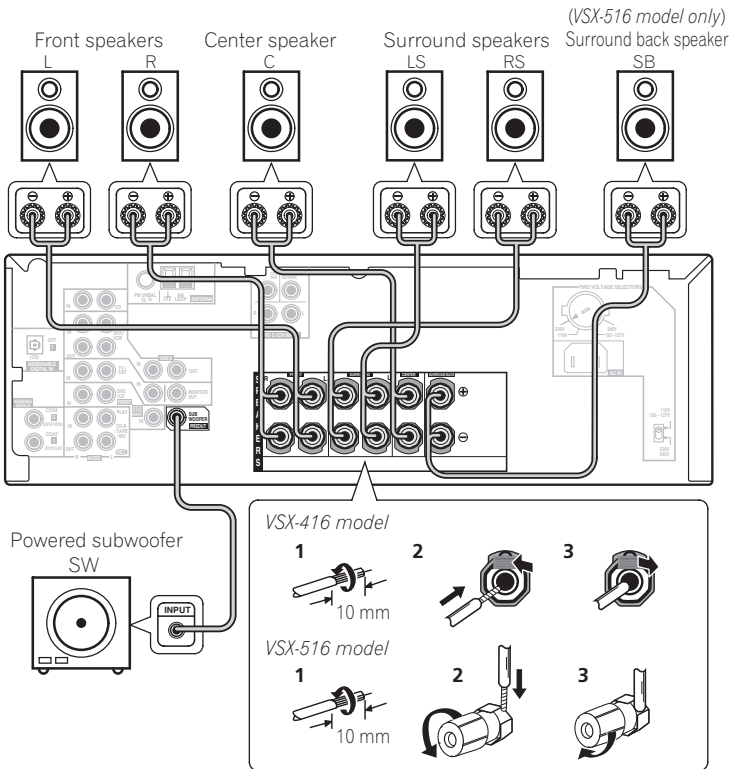

The illustration shows the VSX-516, but connections for the VSX-416 are the same.

V SX-416 model

- 1 **Twist exposed wire strands together.**
- 2 **Push open the tabs and insert exposed wire.**
- 3 **Release the tabs.**

V SX-516 model

- 1 **Twist exposed wire strands together.**
- 2 **Loosen terminal and insert exposed wire.**
- 3 **Tighten terminal.**

Speaker terminals

Make sure that all the bare speaker wire is twisted together and inserted fully into the speaker terminal. If any of the bare speaker wire is touching the back panel when you switch the unit on, the power may cut off as a safety measure. Use good quality speaker wire to connect the speakers to the receiver.



Caution

- These speaker terminals carry **HAZARDOUS LIVE voltage**. To prevent the risk of electric shock when connecting or disconnecting the speaker cables, disconnect the power cord before touching any uninsulated parts.

Hints on speaker placement

Speakers are usually designed with a particular placement in mind. Some are designed to be floorstanding, while others should be placed on stands to sound their best. Some should be placed near a wall; others should be placed away from walls. We have provided a few tips on getting the best sound from your speakers (following), but you should also follow the guidelines on placement that the speaker manufacturer provided with your particular speakers to get the most out of them.

- Place the front left and right speakers at equal distances from the TV.
- When placing speakers near the TV, we recommend using magnetically shielded speakers to prevent possible interference, such as discoloration of the picture when the TV is switched on. If you do not have magnetically shielded speakers and notice discoloration of the TV picture, move the speakers farther away from the TV.
- Place the center speaker above or below the TV so that the sound of the center channel is localized at the TV screen.
- If possible, place the surround speakers slightly above ear level.
- Try not to place the surround speakers further away from the listening position than the front and center speakers. Doing so can weaken the surround sound effect.
- To achieve the best possible surround sound, install your speakers as shown below. Be sure all speakers are installed securely to prevent accidents and improve sound quality.



Caution

- If you choose to install the center speaker on top of the TV, be sure to secure it with putty, or by other suitable means, to reduce the risk of damage or injury resulting from the speaker falling from the TV in the event of external shocks such as earthquakes.
- Make sure no exposed speaker wire is touching the rear panel, this may cause the receiver to turn off automatically.

Speaker placement diagrams

The following illustrations show a 6.1 channel speaker setup.¹

3-D view of 6.1 channel speaker setup



Extra Power mode speaker setup

VSX-416 model only – See *Using the Advanced surround effects* on page 29 to switch on the Extra Power mode (**EX POWER**).

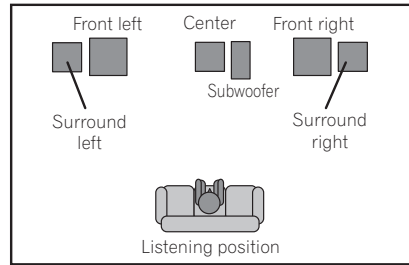

Overhead view of speaker setup

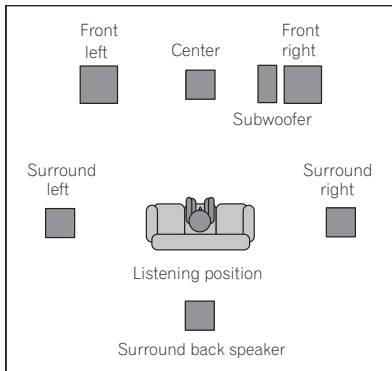

Note

¹ *VSX-416 model only* – Follow the speaker placement diagrams, disregarding the surround back speaker.

Chapter 5: Controls and displays

Front panel

Illustration shows the VSX-516 model

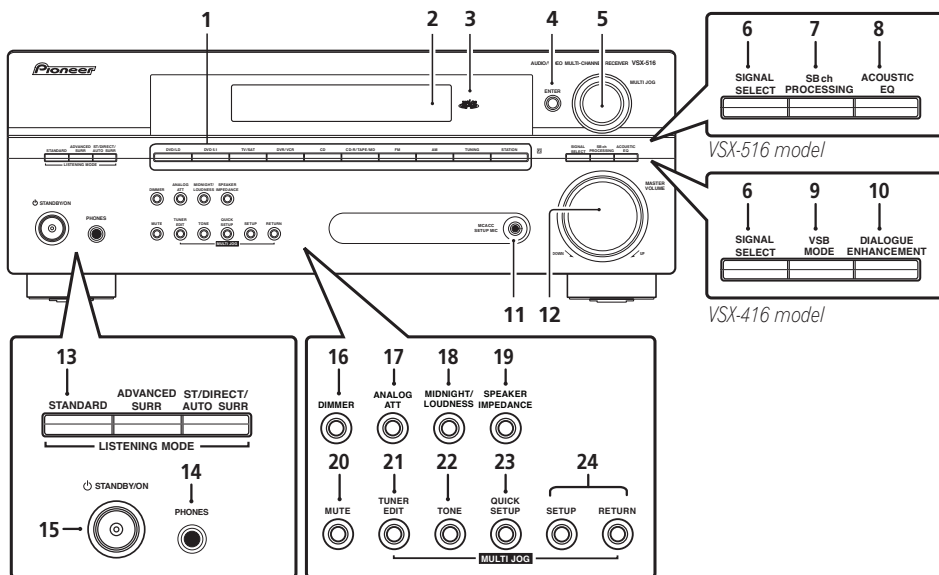

1 Input select buttons

Selects an input source.

2 Character display

See *Display* on page 21.

3 MCACC indicator (VSX-516 model only)

Lights when Acoustic Calibration EQ (page 30) is on (Acoustic Calibration EQ is automatically set to **ALL CH ADJUST** after the Auto MCACC Setup (page 9) or EQ Auto Setup (page 36)).

4 ENTER

5 MULTI JOG dial

The **MULTI JOG** dial performs a number of tasks. Use it to select options after pressing the designated **MULTI JOG** buttons.

6 SIGNAL SELECT

Selects an input signal (page 31).

7 SB ch PROCESSING (VSX-516 model only)

Selects a surround back channel option (page 31) or (when the surround back speaker is not available) the Virtual Surround Back (VSB) mode (page 32).

8 ACOUSTIC EQ (VSX-516 model only)

Press to select an Acoustic Calibration EQ setting (page 30).

9 VSB MODE (VSX-416 model only)

Switches on Virtual surround back processing (page 32).

10 DIALOGUE ENHANCEMENT

(VSX-416 model only)

Use to make dialog stand out when watching TV or a movie (page 33).

11 MCACC SETUP MIC jack

(VSX-516 model only)

Use to connect the supplied microphone.

12 MASTER VOLUME

13 LISTENING MODE buttons

STANDARD

Press for Standard decoding and to switch between the various Pro Logic II and (VSX-516 model only) Neo:6 options (page 28).

ADVANCED SURR

Switches between the various surround modes (page 29).

ST/DIRECT/AUTO SURR

Switches between direct and stereo playback. Direct playback bypasses the tone controls for the most accurate reproduction of a source (page 30). Also selects the Auto Surround mode (*Auto playback* on page 28).

14 PHONES jack

Use to connect headphones (when connected, there is no sound output from the speakers).

15 STANDBY/ON

16 DIMMER

Dims or brightens the display.

17 ANALOG ATT

Attenuates (lowers) the level of an analog input signal to prevent distortion.

18 MIDNIGHT/LOUDNESS

Switches to Midnight/Loudness listening (page 33).

19 SPEAKER IMPEDANCE

Use to change the speaker impedance setting (page 52).

20 MUTE

21 TUNER EDIT

Memorizes/names stations for recall (page 41).

22 TONE

Press this button to access the bass and treble controls, which you can then adjust with the **MULTI JOG** dial (page 33).

23 QUICK SETUP

See *Note* on page 8.

24 System Setup menu controls

SETUP

Use with the **MULTI JOG** dial to access the System Setup menu (page 34).

RETURN

Confirms and exits the current menu.

Display

Illustration shows the VSX-516 model

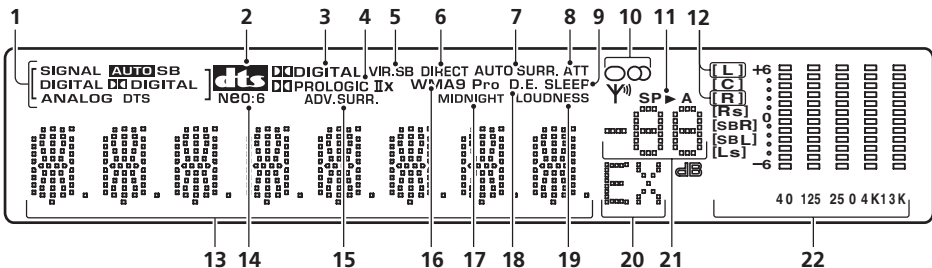

1 SIGNAL SELECT indicators

Lights to indicate the type of input signal assigned for the current component:

AUTO

Lights when **AUTO** signal select is on.

SB (*VSX-516 model only*)

Depending on the source, this lights when a signal with surround back channel encoding is detected.

DIGITAL

Lights when a digital audio signal is detected.

DTS

Lights when a source with DTS encoded audio signals is detected.

DIGITAL

Lights when a Dolby Digital encoded signal is detected.

ANALOG

Lights when an analog signal is detected.



2 

Lights to indicate decoding of a DTS multichannel signal.

3  DIGITAL

Lights to indicate decoding of a Dolby Digital multichannel signal.

4  PRO LOGIC IIx (*VSX-516 model*) /** PRO LOGIC II** (*VSX-416 model*)

 PRO LOGIC II lights to indicate Pro Logic II decoding. ** PRO LOGIC IIx** lights to indicate Pro Logic IIx decoding (see *Listening in surround sound* on page 28 for more on this).

5 VIR.SB

Lights during Virtual surround back processing (page 32).

6 DIRECT

Lights when source direct playback is in use. Direct playback bypasses the tone controls for the most accurate reproduction of a source.

7 AUTO SURR.

Lights when the Auto Surround feature is switched on (see *Auto playback* on page 28).

8 ATT

Lights when **ANALOG ATT** is used to attenuate (reduce) the level of the analog input signal.

9 SLEEP

Lights when the receiver is in sleep mode.

10 Tuner indicators** / MONO**

Lights when the mono mode is set using the **MPX** button.

 / STEREO

Lights when a stereo FM broadcast is being received in auto stereo mode.

 / TUNED

Lights when a broadcast is being received.

11 Speaker indicator

Shows if the speaker system is on or not.

SP▶A means the speakers are switched on.

SP▶ means the headphones are connected.

12 Sound Retriever indicators

(*VSX-516 model only*)

Light when the Sound Retriever is switched on (page 33).

13 Character display

14 Neo:6 (*VSX-516 model only*)

Lights to indicate Neo:6 processing.

15 ADV.SURR (Advanced Surround)

Lights when one of the Advanced Surround modes has been selected.

16 WMA9 Pro

Lights to indicate decoding of a WMA9 Pro signal.

17 MIDNIGHT

Lights during Midnight listening (page 33).

18 D.E.

Lights when Dialog Enhancement (**DIALOG E**) is switched on (page 33).

19 LOUDNESS

Lights during Loudness listening (page 33).

20 EX (*VSX-516 model only*)

Lights when a Dolby Digital Surround EX encoded signal is detected.

21 Master volume level

22 MCACC channel EQ indicators

(VSX-516 model only)

These indicators show the EQ balance for each channel in *Checking your Acoustic Calibration EQ settings* on page 37.

Remote control (VSX-516)

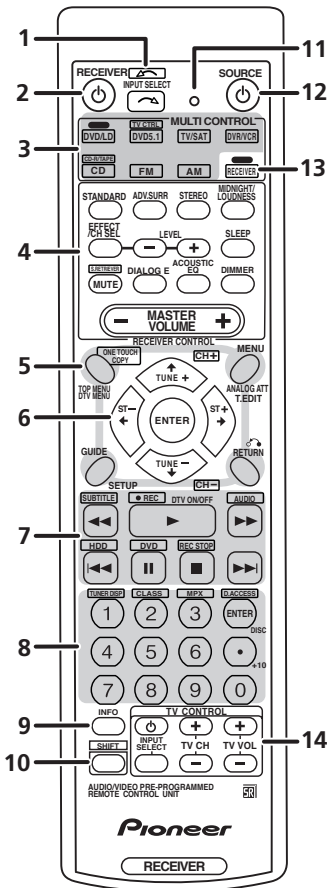

1 INPUT SELECT

Use to select the input source (use **SHIFT** for **INPUT SELECT**).

2 RECEIVER

This switches between standby and on for this receiver.

3 MULTI CONTROL buttons

Press to select control of other components (see *Controlling the rest of your system* on page 44).

4 RECEIVER CONTROL buttons

STANDARD

Press for Standard decoding and to switch between the various Pro Logic IIx and Neo:6 options (page 28).

ADV.SURR

Switches between the various surround modes (page 29).

STEREO

Switches between direct and stereo playback. Direct playback bypasses the tone controls and any other signal processing for the most accurate reproduction of a source (page 30). Also selects the Auto Surround mode (*Auto playback* on page 28).

MIDNIGHT/LOUDNESS

Switches to Midnight or Loudness listening (page 33).

EFFECT/CH SEL

Press repeatedly to select a channel, then use **LEVEL +/-** to adjust the level (page 39). Also adjusts the level of the Advanced Surround effects as well as Dolby Pro Logic IIx Music and Neo:6 Music parameters (page 29). You can then use the **LEVEL +/-** buttons to make these adjustments.

LEVEL +/-

Use to adjust the Advanced Surround effect and channel levels, as well as to change Dolby Pro Logic IIx Music and Neo:6 Music parameter settings.

SLEEP

Press to change the amount of time before the receiver switches into standby (**30 min – 60 min – 90 min – Off**). You can check the remaining sleep time at any time by pressing **SLEEP** once.

S. RETRIEVER*

Press to restore CD quality sound to compressed audio sources (page 33).

MUTE

Mutes/unmutes the sound.

DIALOG E

Use to make dialog stand out when watching TV or a movie (page 33).

ACOUSTIC EQ

Press to select an Acoustic Calibration EQ setting (page 30).

DIMMER

Dims or brightens the display.

MASTER VOLUME +/-

Use to set the listening volume.

5 SYSTEM SETUP and Component control buttons

The following button controls can be accessed after you have selected the corresponding **MULTI CONTROL** button (**DVD/LD**, **TV/SAT**, **RECEIVER**, etc.)

TOP MENU

Displays the disc 'top' menu of a DVD.

DTV MENU

Displays menus on a digital TV.

ONE TOUCH COPY*

Copies the currently playing title from DVD to HDD or vice-versa.

GUIDE

Displays the guides on a digital TV.

SETUP

Use to access the System Setup menu (see page 34).

MENU

Displays the disc menu of DVD-Video discs.

ANALOG ATT

Attenuates (lowers) the level of an analog input signal to prevent distortion.

T.EDIT

Press to memorize and name a station for recall (page 41).

RETURN

Press to confirm and exit the current menu (also use to return to the previous menu with DVDs or to select closed captioning with DTV).

6 ←→↓↑ (TUNE/ST +/-) /ENTER

Use the arrow buttons when setting up your surround sound system (see page 34). Also used to control DVD menus/options and for deck 1 of a double cassette deck player. Use the **TUNE +/-** buttons to find radio frequencies and use **ST +/-** to find preset stations (page 41). Use the **(SHIFT+) CH +/-** buttons to select channels.

7 Component control buttons

The main buttons (▶, ■, etc.) are used to control a component after you have selected it using the **MULTI CONTROL** buttons.

The controls above these buttons can be accessed after you have selected the corresponding **MULTI CONTROL** button (for example **DVD/LD**, **DVR/VCR** or **TV/SAT** (when connected to a DTV)).

DTV ON/OFF

Switches a digital TV on/off.

SUBTITLE*

Displays/changes the subtitles included in multilingual DVD-Video discs.

●REC*

Start recording.

AUDIO*

Changes the audio language or channel on DVD discs.

HDD/DVD*

These buttons switch between the hard disk and DVD controls for DVD/HDD recorders.

REC STOP*

Stops recording.

8 Number buttons and other component controls

Use the number buttons to directly select a radio frequency (page 41) or the tracks on a CD, DVD, etc.

DISC (ENTER) can be used to enter commands for TV or DTV, and can also be used to select a disc in a multi-CD player.

TUNER DISP*

Switches between named station presets and radio frequencies (page 42).

CLASS*

Switches between the three banks (classes) of radio station presets (page 41).

MPX*

Switches between stereo and mono reception of FM broadcasts. If the signal is weak then switching to mono will improve the sound quality (page 41).

D. ACCESS*

After pressing, you can access a radio station directly using the number buttons (page 41).

9 INFO

Use to bring up information screens on a digital TV.

10 SHIFT

Press to access the 'boxed' commands (above the buttons) on the remote. These buttons are marked with an asterisk (*) in this section.

11 Remote control LED

Lights when a command is sent from the remote control.

12 SOURCE

Press to turn on/off other components connected to the receiver (see page 44 for more on this).

13 RECEIVER

Switches the remote to control the receiver (used to select the green commands above the number buttons (**SETUP**, etc)). Also use this button to set up surround sound (page 8, page 34).

14 TV CONTROL buttons

These buttons are dedicated to control the TV assigned to the **TV CTRL** button. Thus if you only have one TV to hook up to this system assign it to the **TV CTRL MULT CONTROL** button. If you have two TVs, assign the main TV to the **TV CTRL** button (see page 44 for more on this).



Use to turn on/off the power of the TV.

INPUT SELECT

Use to select the TV input signal.

TV CH +/-

Use to select channels.

TV VOL +/-

Use to adjust the volume on your TV.

Remote control (VSX-416)

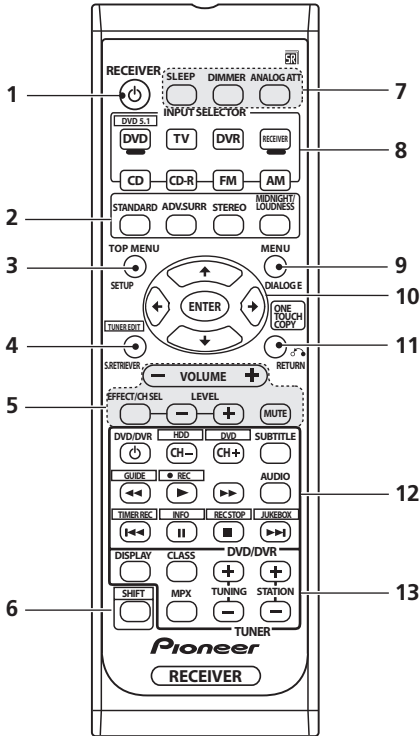

1 RECEIVER

Switches the receiver between standby and on.

2 Listening mode buttons

STANDARD

Press for Standard decoding and to switch between  Pro Logic II.

ADV.SURR

Switches between the various surround modes (page 29).

STEREO

Switches between direct and stereo playback (page 30). Also selects the Auto Surround mode (Auto playback on page 28).

MIDNIGHT/LOUDNESS

Switches to Midnight or Loudness listening (page 33).

3 TOP MENU

Displays the disc 'top' menu of a DVD.

SETUP

Press to access the System Setup menu (page 34).

4 TUNER EDIT*

Memorizes/names stations for recall (page 41). Also functions as the **SETUP** button for DVD/DVR units.

S. RETRIEVER

Press to restore CD quality sound to compressed audio sources (page 33).

5 RECEIVER CONTROL buttons

VOLUME +/-

Use to set the listening volume.

EFFECT/CH SEL

Press repeatedly to select a channel, then use **LEVEL +/-** to adjust the level (page 39). Also adjusts the level of the Advanced Surround effects as well as Dolby Pro Logic II Music parameters (Page 28). You can then use the **LEVEL +/-** buttons to make these adjustments.

LEVEL +/-

Use to adjust the effect and channel levels.

MUTE

Mutes/unmutes the sound.

6 SHIFT

Press to access the 'boxed' commands (above the buttons) on the remote. These buttons are marked with an asterisk (*) in this section.

7 SLEEP

Press to change the amount of time before the receiver switches into standby (**30 min – 60 min – 90 min – Off**). You can check the remaining sleep time at any time by pressing **SLEEP** once.

DIMMER

Dims or brightens the display.

ANALOG ATT

Attenuates (lowers) the level of an analog input signal to prevent distortion.

8 INPUT SELECTOR buttons

Press to select an input source.

DVD/DVR

Press to use the remote DVD/DVR controls.

RECEIVER

Use to switch to the receiver controls on the remote control. Use when setting up surround sound for the receiver (page 34).

9 MENU

Displays the disc menu of DVD-Video discs.

DIALOG E

Use to make dialog stand out when watching TV or a movie (page 33).

10 ↑↓↔/ENTER

Use the arrow buttons when setting up your surround sound system (page 34). Also used for DVD menus.

11 RETURN

Confirm and exit the current menu screen.

ONE TOUCH COPY*

Copies the currently playing title from DVD to HDD or vice-versa.

12 DVD/DVR control buttons

Use these buttons to control a Pioneer DVD player or recorder connected to your system (press **DVD** or **DVR** to access the below controls).

Button	What it does
DVD/ DVR ⏻	Turns DVD power on/off.
CH +/-	Switches channels.
SUBTITLE	Displays/changes the subtitles on multilingual DVD-Video discs.
AUDIO	Changes audio language or channel.

Button	What it does
▶	Starts/resumes normal playback.
⏸	Pauses/unpauses a disc.
■	Stops playback.
◀◀/▶▶	Press to start fast reverse/forward scanning.
⏮	Skips to the start of the current track or chapter, then previous tracks/chapters.
⏭	Skips to the next track or chapter.
HDD/ DVD *	Switch between the hard disk and DVD controls for DVD/HDD recorders.
GUIDE *	Displays the guides on a digital TV.
● REC *	Starts recording.
TIMER REC *	Accesses the timer recording menu.
INFO *	Displays additional EPG information.
REC STOP *	Stops recording.
JUKE BOX *	Switches to the Jukebox feature.
TUNER EDIT *	Press to access the Setup menu.

13 TUNER controls

The **TUNING +/-** buttons can be used to find radio frequencies (page 41) and the **STATION +/-** buttons can be used to select preset radio stations (page 42).

DISPLAY

Switch the display between station preset name and frequency (see *Tip* on page 42).

CLASS

Switches between the three banks (classes) of station presets (page 41).

MPX

Use to switch between auto stereo and mono reception of FM broadcasts. If the signal is weak then switching to mono will improve the sound quality (page 41).

Chapter 6:

Listening to your system

**Important**

- Certain features explained in this section will not be possible depending on the source (for example, PCM 88.2 kHz / 96 kHz, DTS 96 kHz (24 bit) or WMA 9 Pro sources).

Auto playback

The simplest, most direct listening option is the Auto Surround feature. With this, the receiver automatically detects what kind of source you're playing and selects multichannel or stereo playback as necessary.¹



Above: VSX-416 (left) and VSX-516 (right)

- **While listening to a source, press STEREO for auto playback of a source.** Press repeatedly until **AUTOSURR.** shows briefly in the display (it will then show the decoding or playback format). Check the digital format indicators in the display to see how the source is being processed.

Listening in surround sound

Using this receiver, you can listen to any source in surround sound. However, the options available will depend on your speaker setup and the type of source you're listening to. *VSX-516 only* – If you connected surround back speaker, see also *Using surround back channel processing* on page 31.



Above: VSX-416 (left) and VSX-516 (right)

- **While listening to a source, press STANDARD.**

If the source is Dolby Digital, DTS, or Dolby Surround encoded, the proper decoding format will automatically be selected and shows in the display.²

With two channel sources, press **STANDARD** repeatedly to select from³:

VSX-416 model:

- **Pro Logic II MOVIE** – Up to 5.1 channel sound, especially suited to movie sources
- **Pro Logic II MUSIC** – Up to 5.1 channel sound, especially suited to music sources
- **Pro Logic II GAME** – Up to 5.1 channel sound, especially suited for video games
- **PRO LOGIC** – 4.1 channel surround sound (Sound from the surround speakers is mono.)

Note

¹ • *VSX-516 model only* – Stereo surround (matrix) formats are decoded accordingly using **Neo:6 CINEMA** or **Pro Logic IIx MOVIE** (see *Listening in surround sound* above for more on these decoding formats).

• The Auto Surround feature is canceled if you connect headphones or select the multichannel analog inputs.

² *VSX-516 model only* – If surround back channel processing (page 31) is switched to **OFF**, or the surround back speaker is set to **NO** (page 38), **Pro Logic IIx** becomes **Pro Logic II** (5.1 channel sound).

³ When listening to 2-channel sources in Dolby Pro Logic II(x) Music mode, there are three further parameters you can adjust: Center Width, Dimension, and Panorama. See *Setting the effect options* below to adjust them.

Listening to your system

VSX-516 model:

- **Pro Logic IIx MOVIE** – Up to 6.1 channel sound, especially suited to movie sources
- **Pro Logic IIx MUSIC** – Up to 6.1 channel sound, especially suited to music sources
- **Pro Logic IIx GAME** – Up to 6.1 channel sound, especially suited for video games
- **PRO LOGIC** – 4.1 channel surround sound (Sound from the surround speakers is mono.)
- **Neo:6 CINEMA** – 6.1 channel sound, especially suited to movie sources
- **Neo:6 MUSIC**¹ – 6.1 channel sound, especially suited to music sources

*VSX-516 model only – With multichannel sources, if you have connected surround back speaker and have selected **SB ON**, you can select (according to format):*

- **Pro Logic IIx MUSIC** – See above
- **Dolby Digital EX** – Creates surround back channel sound for 5.1 channel sources and provides pure decoding for 6.1 channel sources (like Dolby Digital Surround EX)
- **DTS-ES** – Allows you to hear 6.1 channel playback with DTS encoded sources

Using the Advanced surround effects

The Advanced surround feature creates a variety of surround effects. Try different modes with various soundtracks to see which you like.²



Above: VSX-416 (left) and VSX-516 (right)

- **Press 'ADV.SURR' repeatedly to select a listening mode.**
- **ADV. MOVIE** – Suitable for movie sources
- **ADV. MUSIC** – Suitable for music sources
- **TV SURR.** – Provides surround sound for both mono and stereo TV sources
- **SPORTS** – Suitable for sports programs
- **ADV. GAME** – Suitable for video games
- **EXPANDED** – Simulates multichannel surround sound for two-channel sources³
- **6-STEREO (VSX-516 model only)** – Gives multichannel sound to a stereo source, using all of your speakers
- **VIR. SURR** – A virtual surround effect using just the subwoofer and front speakers
- **EX POWER (VSX-416 model only)** – Select when using the surround speakers in addition to the front speakers (see *the diagram* on page 19 for the Extra Power mode speaker setup)
- **PHONESUR.** – Creates the effect of overall surround with headphones

Setting the effect options

When using surround effects, there are a number of settings you can adjust.

1 Press **EFFECT/CH SEL** repeatedly to select the setting you want to adjust.

Depending on the current status / mode of the receiver, certain options may not appear. Check the table below for notes on this.

2 Use the **LEVEL +/-** buttons to set it as necessary.

See the table below for the options available for each setting. The defaults, if not stated, are listed in bold.

Note

¹ With 2-channel sources in Neo:6 Music mode, you can adjust the center image effect (see *Setting the effect options* below).

² If you press **ADV.SURR** with the headphones connected, **PHONES SURROUND** will automatically be selected.

• Depending on the source and the sound mode you have selected, you may not get sound from the surround back speaker in your setup. For more on this, refer to *Using surround back channel processing* on page 31.

• When an Advanced Surround listening mode is selected, the effect level can be adjusted using the **EFFECT** parameter in *Setting the effect options* below.

³ Use with Dolby Pro Logic for a stereo surround effect (stereo field is wider than Standard modes with Dolby Digital sources).

3 Press EFFECT/CH SEL again to adjust other settings.

Setting	What it does	Options
Center Width^a (Applicable only when using a center speaker)	Spreads the center channel between the front right and left speakers, making it sound wider (higher settings) or narrower (lower settings).	0 to 7 Default: 3
Dimension^a	Adjusts the surround sound balance from front to back, making the sound more distant (minus settings), or more forward (positive settings).	-3 to +3 Default: 0
Panorama^a	Extends the front stereo image to include surround speakers for a 'wraparound' effect.	OFF <i>ON</i>
Center Image^b (Applicable only when using a center speaker)	Adjusts the center image to create a wider stereo effect with vocals. Adjust the effect from 0 (all center channel sent to front right and left speakers) to 10 (center channel sent to the center speaker only).	0 to 10 Default: 3
Effect	Sets the effect level for the currently selected Advanced Surround mode (each mode can be set separately).	10 to 90 Default: 7-STEREO -90 / Others -70

a Only available with 2ch sources in Dolby Pro Logic II(x) Music mode.

b Only available with 2ch sources in Neo:6 Music mode.

Listening in stereo

When you select **STEREO** or **DIRECT**, you will hear the source through just the front left and right speakers (and possibly your subwoofer depending on your speaker settings).

Dolby Digital, DTS and WMA9 Pro multi-channel sources are downmixed to stereo.



Above: VSX-416 (left) and VSX-516 (right)

- **While listening to a source, press STEREO for stereo playback.**

Press repeatedly to switch between:

- **STEREO** – The audio is heard with your surround settings and you can still use the Midnight, Loudness, and Tone functions.
- **DIRECT** – Bypass all effects and surround settings so that the audio remains as close to the source audio signal as possible.¹
- **AUTO SURR.** – See *Auto playback* on page 28 for more on this.

Listening with Acoustic Calibration EQ

VSX-516 model only

- Default setting: **OFF / ALL CH** (after the Auto MCACC Setup or EQ Auto Setting)

You can listen to sources using the Acoustic Calibration Equalization set in *Automatically setting up for surround sound (MCACC)* on page 9 or *Acoustic Calibration EQ* on page 36. Refer to these pages for more on Acoustic Calibration Equalization.



Note

¹ If you switch on Midnight listening, Loudness, Dialog Enhancement, the Sound Retriever or the Tone controls when **DIRECT** is selected, the receiver automatically switches to **STEREO**.

Listening to your system

- While listening to a source, press **ACOUSTIC EQ**.

Press repeatedly to select between:

- **ALL CH** – No special weighting is given to any one channel.
- **F. ALIGN** – All speakers are heard in accordance with the front speaker settings.
- **CUSTOM 1/2** – Custom settings
- **EQ OFF** – Switches Acoustic Calibration EQ off.

The MCACC indicator on the front panel lights when Acoustic Calibration EQ is active.¹

Choosing the input signal

- Default setting: **AUTO**

You need to hook up a component to both analog and digital inputs on the rear of the receiver to select between input signals.²

- Press **SIGNAL SELECT (front panel)** to select the input signal corresponding to the source component.

Each press cycles through the following:

- **AUTO** – This automatically switches to **DIGITAL** if a digital source is detected, otherwise it remains on **ANALOG**
- **ANALOG** – Selects the analog inputs
- **DIGITAL** – Selects the digital input

When set to **DIGITAL** or **AUTO**, **⏏ DIGITAL** lights when a Dolby Digital signal is input, and **DTS** lights when a DTS signal is input.

Using surround back channel processing

V SX-516 model only

- Default setting: **SB ON**

You can have the receiver automatically use 6.1 decoding for 6.1 encoded sources (for example, Dolby Digital EX or DTS-ES), or you can choose to always use 6.1 decoding (for example, with 5.1 encoded material). With 5.1 encoded sources, a surround back channel will be generated, but the material may sound better in the 5.1 format for which it was originally encoded (in which case, you can simply switch surround back processing off).³

The table below indicates when you will hear the surround back channel (●=Sound plays through surround back speaker).

- Press **SB ch PROCESSING** to select a surround back channel option.

Each press cycles through the following:

- **SB ON** – 6.1 decoding is always used (for example, a surround back channel will be generated for 5.1 encoded material)
- **SB AUTO** – Automatically switches to 6.1 decoding for 6.1 encoded sources (for example, Dolby Digital EX or DTS-ES)
- **SB OFF** – Maximum 5.1 playback

Note

- 1 You can't use Acoustic Calibration EQ with **DVD 5.1ch** or **WMA9 Pro**, and it has no effect when headphones are connected.
 - If you switch on Acoustic Calibration EQ when **DIRECT** is selected, the receiver automatically switches to **STEREO**.
- 2 This receiver can only playback Dolby Digital, PCM (32 kHz to 96 kHz), DTS and WMA9 Pro digital signal formats. With other digital signal formats, set to **ANALOG**.
 - You may get digital noise when a LD or CD player compatible with DTS is playing an analog signal. To prevent noise, make the proper digital connections (page 12) and set the signal input to **DIGITAL**.
 - Some DVD players don't output DTS signals. For more details, refer to the instruction manual supplied with your DVD player.
- 3 You can't use the surround back channel with headphones, the **STEREO / DIRECT** mode, or if the surround back speaker is set to **NO** in *Speaker setting* on page 38.

Using Virtual Surround Back (VSB)

When you're not using surround back speaker, selecting this mode allows you to hear a virtual surround back channel through your surround speakers. You can choose to listen to sources with no surround back channel information, or if the material sounds better in the format (for example, 5.1) for which it was originally encoded, you can have the receiver only apply this effect to 6.1 encoded sources like Dolby Digital EX or DTS-ES.¹

VSX-516 model only – The table indicates when you will hear the virtual surround back channel (● = Sound plays through surround speaker).

• Press **SB ch PROCESSING / VSB MODE** to select a virtual surround back channel option. Each press cycles through the following:

- **VSB ON** – Virtual Surround Back is always used (for example, on 5.1 encoded material)
- **VSB AUTO** (*VSX-516 model only*) – Virtual Surround Back is automatically applied to 6.1 encoded sources (for example, Dolby Digital EX or DTS-ES)
- **VSB OFF** – Virtual Surround Back mode is switched off

Type of source	SBch Processing / Virtual SB mode	Standard				Advanced surround
		Multichannel sources	Stereo sources			
			Dolby Pro Logic II x	Dolby Pro Logic	Neo:6	
Dolby Digital EX/DTS-ES/WMA9 Pro encoded multichannel sources with 6.1ch surround	ON	●				● ^a
	AUTO	●				● ^a
Dolby Digital/DTS/WMA9 Pro encoded multichannel sources	ON	●				● ^a
	AUTO					● ^a
Dolby Digital/DTS/WMA9 Pro encoded stereo source; other digital stereo source	ON		●	● ^{a,b}	●	● ^a
	AUTO		● ^c		●	● ^a
Analog 2-channel (stereo) sources	ON		●	● ^b	●	●
	AUTO		● ^c		●	●

a Excluding WMA9 Pro format

b Only applicable when using the Virtual Surround Back mode.

c Not applicable when using the Virtual Surround Back mode.

Note

¹ • You can't use virtual surround back with headphones, the **STEREO / DIRECT** mode, or if the surround speaker is set to **NO** in *Speaker setting* on page 38 (*VSX-516 model only* – however, the surround *back* speaker *must* be set to **NO**).

- Depending on the input signal and the Listening Mode, the Virtual Surround Back mode may not be effective.

Listening to your system

Using Midnight and Loudness

These features give you good sound at low volume levels when listening to movie (Midnight) or music (Loudness) sources.

- Press **MIDNIGHT/LOUDNESS** to switch between **MIDNIGHT**, **LOUDNESS**, and **OFF**.

Enhancing dialog

- Default setting: **OFF**

The Dialog Enhancement feature localizes dialog in the center channel to make it stand out from other background sounds in a TV or movie soundtrack.

- Press **DIALOG E (DIALOGUE ENHANCEMENT)** to switch dialog enhancement on or off.

Using the tone controls

Depending on what you are listening to, you may want to adjust the bass or treble using the front panel tone control.

- 1 Press **TONE** to select the frequency you want to adjust.

Press to switch between **BASS** and **TREBLE**.

- 2 Use the **MULTI JOG** dial to change the amount of bass or treble as necessary.

Wait about five seconds for your changes to be input automatically.

Using the Sound Retriever

When audio data is removed during the compression process, sound quality often suffers from an uneven sound image. The Sound Retriever feature employs new DSP technology that helps bring CD quality sound back to compressed 2-channel audio by restoring sound pressure and smoothing jagged artifacts left over after compression.¹

- Press **S. RETRIEVER** to switch the sound retriever on or off.

Playing other sources

- 1 Turn on the power of the playback component.
- 2 Turn on the power of the receiver.
- 3 Select the source you want to playback.

Use the input select buttons (**INPUT SELECTOR**).

- 4 Start playback of the component you selected in step 1.

Selecting the multichannel analog inputs

If you have connected a decoder or a DVD player with multichannel analog outputs to this receiver (page 13), you must select the analog multichannel inputs for surround sound.²

- Press **DVD 5.1 (VSX-516 model) / DVD5.1 (SHIFT+DVD) (VSX-416 model)** on the remote control or **DVD 5.1** on the front panel.

To cancel playback from the multichannel inputs, use the **INPUT SELECTOR** buttons to select a different input signal.

Note

¹ The Sound Retriever is only applicable to 2-channel sources.

² During playback from the multichannel inputs, you can't use any of the sound features/modes and only the volume and channel levels can be set.

Chapter 7:

The System Setup menu

Using the System Setup menu

The following section shows you how to make detailed settings to specify how you're using the receiver. It also explains how to fine-tune individual speaker system settings.

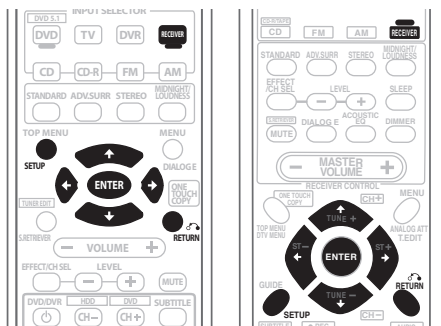

Above: VSX-416 (left) and VSX-516 (right)

1 Press RECEIVER on the remote control, then press the SETUP button.

2 Use ↑/↓ to select the setting you want to adjust then press ENTER.

- **A. MCACC (VSX-516 only)** – This is a quick and effective automatic surround setup (see *Automatically setting up for surround sound (MCACC)* on page 9).
- **M. MCACC (VSX-516 only)** – Fine tune your speaker settings and customize the Acoustic Calibration EQ (see *Manual MCACC speaker setup* below).
- **SP SETUP** – Specify the size, number, distance and overall balance of the speakers you've connected (see *Manual MCACC speaker setup* below).
- **IN ASSIG.** – Specify what you've connected to the digital inputs (see *The Input Assign menu* on page 39).

- **OTHER** – Make customized settings to reflect how you are using the receiver (see *The Other setup menu* on page 40).

Manual MCACC speaker setup

VSX-516 model only

You can use the settings in the Manual MCACC setup menu to make detailed adjustments when you're more familiar with the system. Before making these settings, you should have already completed *Automatically setting up for surround sound (MCACC)* on page 9.

You only need to make these settings once (unless you change the placement of your current speaker system or add new speakers).



Important

- For some of the settings below, you'll have to connect the setup microphone to the front panel and place it about ear level at your normal listening position. See *Automatically setting up for surround sound (MCACC)* on page 9 if you're unsure how to do this. Also see *Other problems during Auto MCACC* on page 10 for notes regarding high background noise levels and other possible interference.
- If you're using a subwoofer, switch it on and turn up the volume to the middle position.

1 Select 'M. MCACC' from the System Setup menu.

See *Using the System Setup menu* above if you're not already at this menu.

2 Select the setting you want to adjust.

If you're doing this for the first time, you might want to make these settings in order.

The System Setup menu

- **CH LEVEL** – Make fine adjustments to the overall balance of your speaker system (see *Fine Channel Level* below).
- **SP DISTN.** – Make precise delay settings for your speaker system (see *Fine Speaker Distance* below).

The last five settings are specifically for customizing the parameters explained in *Acoustic Calibration EQ* on page 36:

- **EQ A. SET** – Measure the acoustic characteristics of your room and automatically adjust the frequency balance of your speaker system (see *Setting the Acoustic Calibration EQ automatically* on page 36).
- **EQ COPY** – Copy Acoustic Calibration EQ settings for manual adjustment (see *Copying your Acoustic Calibration EQ settings* on page 36).
- **C1 ADJ/C2 ADJ** – Make detailed manual adjustments to your custom Acoustic Calibration EQ settings (see *Setting the Acoustic Calibration EQ manually* on page 37).
- **EQ CHECK** – Check the **ALL CH, F. ALIGN** and custom settings (see *Checking your Acoustic Calibration EQ settings* on page 37).

Fine Channel Level

- Default setting: **0dB** (all channels)

You can achieve better surround sound by properly adjusting the overall balance of your speaker system. The following setting can help you make detailed adjustments that you may not achieve using the *Automatically setting up for surround sound (MCACC)* on page 9.

1 Select 'CH LEVEL' from the Manual MCACC setup menu.

You'll hear test tones from each speaker in turn. Since the left speaker is the main reference speaker, the level is fixed.

Caution

- The test tones used in the System Setup are output at high volume (the volume increases to **-18 dB** automatically).

2 Use **↑/↓** to select each channel in turn and adjust the levels (**+/- 10 dB**) as necessary.

Use **←/→** to adjust the volume of the selected speaker to match the reference speaker. When it sounds like both tones are the same volume, press **↓** (cursor down) to continue to the next channel.

- For comparison purposes, the reference speaker will change depending on which speaker you select.
- If you want to go back and adjust a channel, simply use **↑/↓** to select it.

3 When you're finished, press **RETURN**.

You will return to the Manual MCACC setup menu.

Fine Speaker Distance

- Default setting: **3 m** (all channels)

For proper sound depth and separation with your system, it is necessary to add a slight bit of delay to some speakers so that all sounds will arrive at the listening position at the same time. The following setting can help you make detailed adjustments that you may not achieve using the *Automatically setting up for surround sound (MCACC)* on page 9.

1 Select 'SP DISTN.' from the Manual MCACC setup menu.

2 Use **←/→** to adjust the distance of the left channel from the listening position then press **ENTER**.

3 Use **↑/↓** to select each channel in turn and adjust the distance as necessary.

Use **←/→** to adjust the delay of the selected speaker to match the reference speaker. The delay is measured in terms of speaker distance from **0.1** to **9.0** meters.

Listen to the reference speaker and use it to measure the target channel. From the listening position, face the two speakers with your arms outstretched pointing at each speaker.

Try to make the two tones sound as if they are arriving simultaneously at a position slightly in front of you and between your arm span.

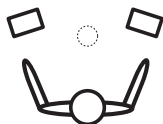

When it sounds like the delay settings are matched up, press **↓** (cursor down) to confirm and continue to the next channel.

- For comparison purposes, the reference speaker will change depending on which speaker you select.
- If you want to go back and adjust a channel, simply use **↑/↓** to select it.

4 When you're finished, press RETURN.

You will return to the Manual MCACC setup menu.

Acoustic Calibration EQ

Acoustic Calibration Equalization is a kind of room equalizer for your speakers (excluding the subwoofer). It works by measuring the acoustic characteristics of your room and neutralizing the ambient characteristics that can color the original source material. This provides a 'flat' equalization setting. If you're not satisfied with the automatic adjustment, you can also adjust these settings manually to get a frequency balance that suits your tastes.

Setting the Acoustic Calibration EQ automatically

If you have already completed *Automatically setting up for surround sound (MCACC)* on page 9, **A. CH ADJ** and **F.ALG ADJ** (below) should already be set. Therefore, if you want to adjust your settings manually, you can skip to *Setting the Acoustic Calibration EQ manually* below.

1 Select 'EQ A. SET' from the Manual MCACC setup menu.

- Make sure the microphone is connected.
- If you're using a subwoofer, it is automatically detected every time you switch on the system. Make sure it is on and the volume is at the middle position.
- See *Other problems during Auto MCACC* on page 10 for notes regarding high background noise levels and other possible interference.

2 Wait for the EQ Auto Setup to finish.

As the receiver outputs test tones, the frequency balance is adjusted automatically for the following settings:

- **A. CH** – *All Channel Adjust* is a 'flat' setting where all the speakers are set individually so no special weighting is given to any one channel.
- **F.ALG** – *Front Align Adjust* balances the overall sound so that all speakers are set in accordance with the front speaker settings (no equalization is applied to the front left and right channels).

You will return to the Acoustic Cal EQ setup menu after the Acoustic Calibration Equalization is set.

Copying your Acoustic Calibration EQ settings

If you want to manually adjust the Acoustic Calibration EQ (see *Setting the Acoustic Calibration EQ manually* below), we recommend copying the **A. CH** or the **F.ALG** settings from the **EQ A. SET** setup above (or from *Automatically setting up for surround sound (MCACC)* on page 9) to one of the custom (**C1** or **C2**) settings. Instead of just a flat EQ curve, this will give you a reference point from which to start.

1 Select 'EQ COPY' from the Manual MCACC setup menu.

The System Setup menu

2 Use ↑/↓ to select C1 or C2 then use the ←/→ buttons to select the setting you want to copy.

- You can also copy from one custom setting to another. For more on the **A. CH** and **F.ALG** settings, see *Setting the Acoustic Calibration EQ automatically* above.

3 Use ↑/↓ to select 'COPY? YES' to copy and confirm.

You can also use ←/→ to select **COPY? NO** to cancel.

Setting the Acoustic Calibration EQ manually

Before manually adjusting the Acoustic Calibration EQ, we recommend copying the **A. CH** or the **F.ALG** settings from the auto setup above (or from *Automatically setting up for surround sound (MCACC)* on page 9) to one of the custom settings. Instead of just a flat EQ curve, this will give you a reference point from which to start (see *Copying your Acoustic Calibration EQ settings* above for how to do this).

1 Select 'C1 ADJ' or 'C2 ADJ' from the Manual MCACC setup menu.

2 Use ←/→ and ENTER to select which method you want to use to adjust the overall frequency balance.

It is best to choose whichever one you copied to the custom setting in *Copying your Acoustic Calibration EQ settings* above.

- A. CH ADJ** – All the speakers can be set independently so no special weighting is given to any one channel. When adjusting, test tones will sound for each individual channel.
- F.ALG ADJ** – Speakers are set in accordance with the front speaker settings. The sound of the test tone will alternate between the left front (reference) speaker and the target speaker.

3 Use ←/→ to select the channel you want and adjust to your liking.

Use the ↑/↓ buttons to select the frequency and ←/→ to boost or cut the EQ. When you're finished, use the ↑/↓ buttons to select the channel display (for example **R EQ** for the right channel or **SB EQ** for the surround back channel) then ←/→ to proceed to the next channel.

- The front speakers can't be adjusted if you selected **F.ALG ADJ**.
- The **OVER!** indicator shows in the display if the frequency adjustment is too drastic and might distort. If this happens, bring the level down until **OVER!** disappears from the display.

Tip

- Changing the frequency curve of one channel too drastically will affect the overall balance. If the speaker balance seems uneven, you can raise or lower channel levels using test tones with the 'trim' band (**TRM** shows in the display). Use ↑/↓ to select **TRM** then use ←/→ to raise or lower the channel level for the current speaker.

4 When you're finished, press RETURN.

Press **RETURN** once more to go back to the Manual MCACC setup menu.

Checking your Acoustic Calibration EQ settings

After you have completed an automatic or manual Acoustic Calibration EQ adjustment, you can check the **ALL CH**, **F.ALIGN** and **CUSTOM1/2** settings in the display.

1 Select 'EQ CHECK' from the Manual MCACC setup menu.

2 Use ←/→ and ENTER to select the setting you want to check.

- It is useful to do this while a source is playing so you can compare settings.

3 Use ←/→ to select the channel you want, using ↑/↓ to check the settings.

The MCACC channel EQ indicators in the front panel display will light accordingly.

4 When you're finished, press RETURN.

You will return to the Manual MCACC setup menu.

Manual speaker setup

These settings optimize surround sound performance (if you're satisfied with the settings made in *Using the Quick Setup* on page 8 or (*VSX-516 only*) *Automatically setting up for surround sound (MCACC)* on page 9, adjustment may not be necessary). You only need to make these settings once (unless you change the placement of your current speaker system or add new speakers).

1 Select SP SETUP from the System Setup menu.

2 Use ↑/↓ to select the setting you want to adjust then press ENTER.

- **SP SET** – Specify size / number of speakers connected (see *Speaker setting* below).
- **X.OVER** – Specify which frequencies will be sent to the subwoofer (see *Crossover network* below).
- **CH LEVEL** – Adjust overall balance of your speaker system (see *Channel level* below).
- **SP DISTN.** – Specify the distance of your speakers from the listening position (see *Speaker Distance* below).

3 Press RETURN after making the adjustments necessary for each setting.

Speaker setting

Use this setting to specify your speaker configuration (size, number of speakers).

1 Select SP SET from the SP SETUP menu.

2 Use ↑/↓ to choose the speaker(s) that you want to set then select a speaker size.

Use ←/→ to select the size of each of the following speakers:

- **Front (F)** – Select **LARGE** if your front speakers reproduce bass frequencies effectively, or if you didn't connect a subwoofer. Select **SMALL** to send the bass frequencies to the subwoofer.¹
- **Center (C)** – Select **LARGE** if your center speaker reproduces bass frequencies effectively, or select **SMALL** to send bass frequencies to the other speakers or subwoofer. If you didn't connect a center speaker, choose **NO** (the center channel is sent to the other speakers).
- **Surround (S)** – Select **LARGE** if your surround speakers reproduce bass frequencies effectively. Select **SMALL** to send bass frequencies to the other speakers or subwoofer. If you didn't connect surround speakers choose **NO** (the sound of the surround channels is sent to the other speakers).
- (*VSX-516 model only*) **Surround Back (SB)** – Select **LARGE** if your surround back speaker reproduce bass frequencies effectively. Select **SMALL** to send bass frequencies to the other speakers or subwoofer. If you didn't connect surround back speaker choose **NO**.²
- **Subwoofer (SW)** – LFE signals and bass frequencies of channels set to **SMALL** are output from the subwoofer when **YES** is selected. Choose the **PLUS** setting if you want the subwoofer to output bass sound continuously or you want deeper bass (the bass frequencies that would normally

Note

¹ If you select **SMALL** for the front speakers the subwoofer is fixed to **YES**. Also, the center, surround, and surround back speaker can't be set to **LARGE** if the front speakers are set to **SMALL**. In this case, all bass frequencies are sent to the subwoofer.

² If the surround speakers are set to **NO**, the surround back speaker will automatically be set to **NO**.

The System Setup menu

come out the front and center speakers are also routed to the subwoofer).¹ If you did not connect a subwoofer choose **NO** (the bass is output from other speakers).

Crossover network

- Default setting: **100Hz**

This setting decides the cutoff between bass sounds playing back from the speakers selected as **LARGE**, or the subwoofer, and bass sounds playing back from those selected as **SMALL**.² It also decides where the cutoff will be for bass sounds in the LFE channel.

- 1 Select '**X.OVER**' from the **SP SETUP** menu.
- 2 Use **←/→** to choose the frequency cutoff point.

Frequencies below the cutoff point will be sent to the subwoofer (or **LARGE** speakers).

Channel level

Using these settings, you can adjust the overall balance of your speaker system.

- 1 Select **CH LEVEL** from the **SP SETUP** menu.
- 2 Use **←/→** to select a setup option.
 - **T. TONE M.** – Move the test tone manually from speaker to speaker and adjust individual channel levels.
 - **T. TONE A.** – Adjust channel levels as the test tone moves from speaker to speaker automatically.

- 3 Confirm your selected setup option.

The test tones will start after you press **ENTER**.³

- 4 Adjust the level of each channel using **←/→**. If you selected **T. TONE M.**, use **↑/↓** to switch speakers.

The **T. TONE A.** setup outputs test tones in the following order (depends on speaker settings):

L → C → R → RS → SB* → LS → SW

**VSX-516 model only*

Adjust the level of each speaker as the test tone is emitted.⁴

Speaker Distance

For good sound depth and separation from your system, you need to specify the distance of your speakers from the listening position.⁵ The receiver can then add the proper delay needed for effective surround sound.

- 1 Select '**SP DISTN.**' from the **SP SETUP** menu.
- 2 Use **↑/↓** to choose the speaker that you want then set the distance. Use **←/→** to adjust the distance of each speaker (in 0.1 meter increments).

The Input Assign menu

You only need to make settings in the Input Assign menu if you didn't hook up your digital equipment according to the default settings for the digital inputs.

Assigning the digital inputs

- Default settings:
 - COAX 1** (coaxial) – **DVD**
 - COAX 2** (coaxial) – **DVR**
 - OPT 1** (optical) – **CD**

Note

¹ If you can't get good bass results, listen to the bass response with the subwoofer set to **PLUS** and **YES** or the front speakers set to **LARGE** and **SMALL** alternatively and let your ears judge which sounds best. If you're having problems, the easiest option is to route all the bass sounds to the subwoofer by selecting **SMALL** for the front speakers.

² For more on selecting the speaker sizes, see *Speaker setting* above.

³ After the volume increases to the reference level, test tones will be output.

⁴ If you are using a Sound Pressure Level (SPL) meter, take the readings from your main listening position and adjust the level of each speaker to 75 dB SPL (C-weighting/slow reading).

- The subwoofer test tone is output at low volumes. You may need to adjust the level after testing with an actual soundtrack.
- You can change the channel levels at any time by using **EFFECT/CH SEL** and **LEVEL +/-** on the remote control. You can set two channel levels: one for **DVD 5.1** and one for the listening modes.

⁵ For best surround sound, make sure the surround back speaker is the same distance from the listening position.

You only need to do this if you didn't connect your digital components according to the defaults above. This tells the receiver what component is connected to which terminal so it corresponds to the buttons on the remote.

1 Select 'IN ASSIG.' from the System Setup menu.

2 Use ↑/↓ to select 'DIG.IN' then press ENTER.

3 Use ↑/↓ to select the number of the digital input to which you've connected your digital component.

The numbers correspond with the numbers beside the inputs on the back of the receiver.

4 Select the component that corresponds with the one you connected to that input.

- Use the ←/→ buttons and **ENTER** to select **DVD, TV, CD, CDR, DVR** or **OFF**.
- If you assign a digital input to a certain function (for example, **DVD**) then any digital inputs previously assigned to that function will automatically be switched off.

5 Press RETURN when you're finished.

The Other setup menu

The Other menu is where you can make customized settings to reflect how you are using the receiver.

1 Select OTHER from the System Setup menu.

2 Use ↑/↓ to select the setting you want to adjust then press ENTER.

If you are doing this for the first time, you may want to adjust these settings in order:

- **DRC** – Specify the amount of dynamic range adjustment to Dolby Digital soundtracks (see *Dynamic Range Control Setup* below).

- **DUAL MONO** – Isolate one channel when listening to discs with dual mono encoding (see *Dual Mono Setup* below).
- **LFE ATT** – Set the attenuator level for the LFE channel (*LFE Attenuator Setup* below).

3 Use ←/→ to make the adjustments necessary for each setting, pressing RETURN to confirm after each screen.

Dynamic Range Control Setup

- Default setting: **OFF**

Specifies the amount of dynamic range adjustment to Dolby Digital or DTS soundtracks:

- **MAX** – Dynamic range is reduced (loud sounds are reduced in volume while quieter sounds are increased).
- **MID** – Mid setting.
- **OFF** – No dynamic range adjustment (use when listening at higher volume).

Dual Mono Setup

- Default setting: **CH1**

Specifies how dual mono encoded Dolby Digital soundtracks should be played:¹

- **CH2** – Only channel 2 is played
- **CH1 CH2** – Both channels are played through the front speakers
- **CH1** – Only channel 1 is played

LFE Attenuator Setup

- Default setting: **LFEATT 0 dB**

Set the LFE attenuator as necessary to prevent ultra-low bass tones (included with some Dolby Digital and DTS audio sources) from distorting the sound from the speakers:

- **LFEATT 0** – No limiting (recommended setting)
- **LFEATT 10** – 10 dB of limiting
- **LFEATT **** – No sound from LFE channel

Note

¹ This setting works only with dual mono encoded Dolby Digital and DTS soundtracks.

Chapter 8:

Using the tuner

Listening to the radio

The following steps show you how to tune in to FM and AM radio broadcasts and memorize the frequency for recall later.

1 Press AM or FM to select the tuner band.

2 Tune to a station.

There are three ways to do this:

Automatic tuning – Press and hold **TUNE +/-** (*VSX-516 model*) / **TUNING +/-** (*VSX-416 model*) for about a second. Searching automatically stops at the next station.

Manual tuning – To change the frequency one step at a time, press **TUNE +/-** (*VSX-516 model*) / **TUNING +/-** (*VSX-416 model*).

High speed tuning – Press and hold **TUNE +/-** (*VSX-516 model*) / **TUNING +/-** (*VSX-416 model*) continuously.

If the signal is weak, press the **(SHIFT +) MPX** (*VSX-516 model*) / **MPX** (*VSX-416 model*) button to switch the receiver into mono reception mode.

Tuning directly to a station

VSX-516 model only

Sometimes, you'll already know the frequency of the station you want to listen to. In this case, you can simply enter the frequency directly using the number buttons on the remote control.

1 Press FM or AM to select the band.

2 Press (SHIFT +) D.ACCESS (Direct Access).

3 Use the number buttons to enter the frequency of the radio station.

For example, to tune to **106.00** (FM), press **1, 0, 6, 0, 0**.

If you make a mistake halfway through, press **(SHIFT +) D.ACCESS** twice to cancel the frequency and start over.

Saving station presets

This receiver can memorize up to 30 stations, stored in three banks of 10 stations each.¹

1 Tune to a station you want to memorize.

2 Press T.EDIT (VSX-516 model) / (SHIFT +) TUNER EDIT (VSX-416 model).

The display shows **ST. MEMORY**, then a blinking memory class.

3 Press (SHIFT +) CLASS (VSX-516 model) / CLASS (VSX-416 model) to select one of the three classes then press ST +/- (VSX-516 model) / STATION +/- (VSX-416 model) to select the station preset you want.

Use the **MULTI JOG** dial after pressing **STATION** (front panel) to select station presets.

4 Press ENTER to store the station.

Naming station presets

You can name your station presets for easy recall.

1 Choose the preset you want to name.

See *Listening to station presets* below.

Note

¹ When saving an FM frequency, the **MPX** setting is also stored.

2 Press 'T.EDIT' (VSX-516 model) / (SHIFT +) TUNER EDIT (VSX-416 model).

A cursor appears at the first character position.

3 Input the name you want then press ENTER.

Names can be up to four characters long.

- Use the **MULTI JOG** dial (front panel) or the **ST +/-** (VSX-516 model) / **STATION +/-** (VSX-416 model) buttons (remote) to select characters, and **ENTER** to confirm. If no character is input, a space is input.



Tip

- Once you have named a station preset, you can press **(SHIFT +) TUNER DISP** (VSX-516 model) / **DISPLAY** (VSX-416 model) when listening to a station to switch the display between the name and the frequency.

Listening to station presets

You will need to have some presets stored to do this. See *Saving station presets* on page 41 if you haven't done this already.

1 Press AM or FM to select the tuner.

2 Press (SHIFT +) CLASS (VSX-516 model) / CLASS (VSX-416 model) to select the class in which the station is stored.

Press repeatedly to cycle through classes A, B and C.

3 Press ST +/- (VSX-516 model) / STATION +/- (VSX-416 model) to select the station preset you want.

Changing the frequency step

If you find that you can't tune into stations successfully, the frequency step may not be suitable for your country/region. Here's how to switch the setting:

1 Switch the receiver into standby.

2 On the front panel, press STANDBY/ON while you press and hold the TUNER EDIT button.

The channel tuning step alternates between **10K STEP** and **9K STEP** each time you do this.

Chapter 9: Making recordings

Making an audio or a video recording

You can make an audio or a video recording from the built-in tuner, or from an audio or video source connected to the receiver (such as a CD player or TV).

Keep in mind you can't make a digital recording from an analog source or vice-versa, so make sure the components you are recording to/from are hooked up in the same way (see *Connecting up* on page 11 for more on connections).

Refer to the instructions that came with the recorder if you are unsure how to do this. Most video recorders set the audio recording level automatically—check the component's instruction manual if you're unsure.

5 Start recording, then start playback of the source component.

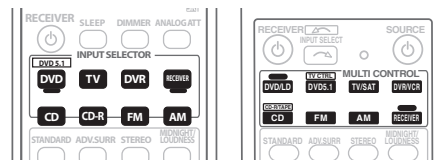

Above: VSX-416 (left) and VSX-516 (right)

1 Select the source you want to record.

Use the input select buttons (**INPUT SELECTOR**).

2 Select the input signal (if necessary).

Press **SIGNAL SELECT** (front panel) to select the input signal corresponding to the source component (see page 31 for more on this).

3 Prepare the source you want to record.

Tune to the radio station, load the CD, video, DVD etc.

4 Prepare the recorder.

Insert a blank tape, MD, video etc. into the recording device and set the recording levels.¹

Note

¹ The receiver's volume, balance, tone (bass, treble, loudness), and surround effects have no effect on the recorded signal.

Chapter 10:

Controlling the rest of your system

VSX-516 model only

Setting the remote to control other components

Most components can be assigned to one of the **MULTI CONTROL** buttons using the component's manufacturer preset code stored in the remote.

However, please note that there are cases where only certain functions may be controllable after assigning the proper preset code, or the codes for the manufacturer in the remote control will not work for the model that you are using.



Note

- After one minute of inactivity, the remote automatically exits the operation.

Selecting preset codes directly



- 1 While pressing the **RECEIVER** button, press and hold the **1** button.

The LED blinks.

Note

- 1 • TV codes (for example, codes for TV, CATV, Satellite TV or DTV) can only be assigned to the **TV/SAT** or **TV CTRL** button.
- You can't assign the **AM** / **FM** or **RECEIVER** buttons.

- 2 Press the **MULTI CONTROL** button for the component you want to control.

The LED lights.

- 3 Use the number buttons to enter the preset code.

You can find the preset codes on page 49.

The LED blinks again after you enter the code.

If the correct code has been input the power of the component being input will turn on or off.

The power of the component being input will only turn on or off if that component is able to be turned on directly by remote control.

- You can only input a code for the component type written on each **MULTI CONTROL** button.¹
- Even if you don't input a preset code for the TV (**TV/SAT MULTI CONTROL** button) you will be able to control your TV using the dedicated **TV CONTROL** on the remote if you have assigned it to the **TV CTRL** button.

- 4 Repeat steps 2 through 3 to try a different code, or to enter a code for another component you want to control.

- 5 When you're done, press **RECEIVER**.

Direct function

- Default setting: **ON**

You can use the direct function feature to control one component using the remote control while at the same time, using your receiver to playback a different component. This could let you, for example, use the remote control to set up and listen to a CD on the receiver and then use the remote control to rewind a tape in your VCR while you continue to listen to your CD player.

When direct function is on, any component you select (using the **MULTI CONTROL** buttons) will be selected by both the receiver and the remote control. When you turn direct function off, you can operate the remote control without affecting the receiver.¹

1 While pressing the RECEIVER button, press and hold the 4 button.

The LED blinks.

2 Press the MULTI CONTROL button for the component you want to control.

The LED lights.

3 Use the number buttons to enter either 1 (direct on) or 2 (direct off).

The LED blinks again.

4 Repeat steps 2 through 3 for the other components you want to control.

5 When you're done, press RECEIVER.

Clearing all the remote control settings

You can clear all presets and restore the factory default settings.

- **While pressing the RECEIVER button, press and hold the 0 button for three seconds.**

The LED blinks three times indicating the settings have been restored to the factory presets.







 **Note**

¹ You can't use direct function with the **AM / FM** and **TV CTRL** functions.

Controls for TVs

This remote control can control components after entering the proper codes or teaching the receiver the commands (see *Setting the remote to control other components* on page 44 for more on this). Use the **MULTI CONTROL** buttons to select the component.

- The **TV CONTROL** buttons on the remote control are dedicated to control the TV assigned to the **TV CTRL** button. If you have two TVs, assign the main TV to the **TV CTRL** button.

Button(s)	Function	Components
TV 	Switches the DTV on or off.	DTV
	Switches the TV or CATV between standby and on.	Cable TV/Satellite TV/TV
INPUT SELECT	Switches the TV input. (Not possible with all models.)	TV
TV CH +/-	Selects channels.	Cable TV/Satellite TV/TV/DTV
TV VOL +/-	Adjust the TV volume.	Cable TV/Satellite TV/TV/DTV
TOP MENU	Use as the TEXT ON button.	TV
	Select different menus from the DTV functions.	DTV
MENU	Select the menu screen.	Cable TV/Satellite TV/TV
AUDIO	Use as the AUDIO button.	Cable TV/Satellite TV/TV/DTV
GUIDE	Use as the GUIDE button for navigating.	Cable TV/Satellite TV/DTV
	Use as the TEXT OFF button.	TV
Number Buttons	Use to select a specific TV channel.	Cable TV/Satellite TV/TV/DTV
(SHIFT +) 7	Use to choose the BLUE commands on a DTV menu.	DTV
(SHIFT +) 8	Use to choose the GREEN commands on a DTV menu.	DTV
(SHIFT +) 9	Use to choose the RED commands on a DTV menu.	DTV
(SHIFT +) 0	Use to choose the YELLOW commands on a DTV menu.	DTV
	Switches DTV on or off.	DTV
	Use to choose the 'A' commands on a Satellite TV menu.	Satellite TV
	Use to choose the 'B' commands on a Satellite TV menu.	Satellite TV
	Use to choose the 'C' commands on a Satellite TV menu.	Satellite TV
	Use to choose the 'D' commands on a Satellite TV menu.	Satellite TV
	Use to choose the 'E' commands on a Satellite TV menu.	Satellite TV

Button(s)	Function	Components
+10 button	Use to add a decimal point when selecting a specific TV channel.	DTV
INFO	Press to get information on DTV programs.	DTV
ENTER/ DISC	Use to enter a channel.	Cable TV/TV/DTV
←→↓↑& ENTER	Select or adjust and navigate items on the menu screen. ENTER brings up the DTV menus.	DTV
	Press to select or adjust and navigate items on the menu screen.	Cable TV/Satellite TV/TV/DTV

Controls for other components

This remote control can control these components after entering the proper codes or teaching the receiver the commands (see *Setting the remote to control other components* on page 44 for more on this). Use the **MULTI CONTROL** buttons to select the component.

Button (s)	Function	Components
SOURCE	Press to switch the component between standby and on.	CD/MD/CD-R/VCR/DVD/LD/ DVR player/Cassette deck
⏮	Press to return to the start of the current track. Repeated presses skips to the start of previous tracks.	CD/MD/CD-R/DVD/LD player
	Play the reverse side of the tape on a reversible deck.	Cassette deck
⏭	Press to advance to the start of the next track. Repeated presses skips to the start of following tracks.	CD/MD/CD-R/DVD/ LD player
⏸	Pause playback or recording.	CD/MD/CD-R/VCR/DVD/LD/ DVR player/Cassette deck
▶	Start playback.	CD/MD/CD-R/VCR/DVD/LD/ DVR player/Cassette deck
⏩	Hold down for fast forward playback.	CD/MD/CD-R/VCR/DVD/LD/ DVR player/Cassette deck
⏪	Hold down for fast reverse playback.	CD/MD/CD-R/VCR/DVD/LD/ DVR player/Cassette deck
■	Stops playback (on some models, pressing this when the disc is already stopped will cause the disc tray to open).	CD/MD/CD-R/VCR/DVD/LD/ DVR player/Cassette deck
● REC (SHIFT+▶)	Starts recording. To prevent accidental recording, this button must be pressed twice to take effect.	MD/CD-R/VCR/ DVR player/ Cassette deck

Button (s)	Function	Components
REC STOP (SHIFT+■)	Stops recording.	DVR player
Number buttons	Directly access tracks on a program source.	CD/MD/CD-R/VCR/LD player
	Use the number buttons to navigate the on-screen display.	DVD/DVR player
+10 button	Selects tracks higher than 10. (For example, press +10 then 3 to select track 13.)	CD/MD/CD-R/VCR/LD player
ENTER/ DISC	Changes the search mode.	DVD
	Chooses the disc.	Multiple CD player
	Use as the ENTER button.	VCR
	Displays the setup screen for DVR players.	DVR player
	Changes sides of the LD.	LD player
TOP MENU	Displays the disc 'top' menu.	DVD/DVR/LD player
MENU	Displays menus concerning the current DVD or DVR you are using.	DVD/DVR player
↑	Pauses the tape.	Cassette deck
↓	Stops the tape.	Cassette deck
ENTER	Starts playback.	Cassette deck
←/→	Fast rewinds/fast forwards the tape.	Cassette deck
←→↓↑ & ENTER	Navigates DVD menu/options.	DVD/DVR player
GUIDE	Displays/changes the subtitles on multilingual DVDs.	DVR player
CH +/- (SHIFT+↓/↑)	Selects channels.	VCR/DVR player
AUDIO (SHIFT+▶▶)	Changes the audio language, channel or track.	DVD/DVR/LD/CD player
SUBTITLE (SHIFT+◀◀)	Displays/changes the subtitles on multilingual DVDs.	DVD/DVR player
HDD (SHIFT+⏪◀)	Switches to the hard disk controls when using a DVD/HDD recorder.	DVR player
DVD (SHIFT+⏩▶)	Switches to the DVD controls when using a DVD/HDD recorder.	DVR player

Preset Code List

You should have no problem controlling a component if you find the manufacturer in this list, but please note that there are cases where codes for the manufacturer in the list will not work for the model that you are using. There are also cases where only certain functions may be controllable after assigning the proper preset code.

DVD

Manufacturer Code

TOSHIBA 001
SONY 002
PANASONIC 003
JVC 004
SAMSUNG 005
SHARP 006
AKAI 007
RCA 009, 011
DENON 010
HITACHI 012
PHILIPS 013
ZENITH 014
THOMSON 015
SONY 016 (video game)
MICROSOFT 017
 (Videogame)
PIONEER 000, 008, 020

LD

Manufacturer Code

SONY 101
PANASONIC 105, 106
PHILIPS 104
KENWOOD 103
RCA 107
PIONEER 100, 111

TV (TV/SAT) (TV/CTL)

Manufacturer Code

RCA 601, 615, 616, 617, 618
ZENITH 603, 620
MAGNAVOX 612, 629
GE 611, 628
GENERAL 666
PHILIPS 607
SONY 604
PANASONIC 608, 622
TOSHIBA 605, 626, 663
SHARP 602, 619, 627
HITACHI 606, 624, 625, 664
SANYO 621, 614
MITSUBISHI 609
GOLDSTAR 610, 623
JVC 613, 665
FUNAI 658

AIWA 660

NEC 659
GRANDIENTE 630
PIONEER 600, 667

STB (SATELLITE/CATV) (TV/SAT) (TV/CTL)

Manufacturer Code

AICHI DENSI 734
DX ANNTENA 732, 733
FUJITSU 722, 723, 724
HITACHI 721
MASPRO 729
NEC 720
PANASONIC 725, 726, 728
SUMITOMO 730
TOSHIBA 719
JERROLD 701, 702, 703, 704,
 711, 712, 713, 714, 715, 716
SA 705, 706, 708, 709, 731
ZENITH 707, 717, 710
PIONEER 700, 718

On digital STB (TV/SAT) (TV/CTL)

Manufacturer Code

RCA 201, 203, 209
SONY 202, 557
ECHOSTAR 205
PRIMESTAR 206
BELL 208
TOSHIBA 555
SHARP 554
AIWA 562, 563, 564
HITACHI 556
JVC 551, 552, 553
MASPRO 559, 560, 561
PANASONIC 558
PIONEER 200

DTV (TV/SAT) (TV/CTL)

Manufacturer Code

PIONEER 207, 229, 231, 232
PANASONIC 226, 230
JVC 227
TOSHIBA 228

VCR

Manufacturer Code

RCA 401, 413, 415
ZENITH 403
MAGNAVOX 414
FISHER 412, 426, 427
PANASONIC 408, 432, 433,
 462, 463, 473
TOSHIBA 405, 464, 474
JVC 407, 428, 429, 430, 431
HITACHI 406, 434, 436, 465,
 472
SONY 404, 416, 417, 457,
 458, 459, 460, 461, 475,
 476, 477, 478
MITSUBISHI 409, 420, 421,
 422, 423, 424, 466, 467,
 470
SANYO 410, 425, 435, 468
SHARP 402, 418, 419, 469,
 471
GOLDSTAR 411
GRADIENTE 441
PIONEER 400

DVD Recorder

Manufacturer Code

PIONEER 456, 487, 488, 489
TOSHIBA 485
PANASONIC 486

TAPE

Manufacturer Code

DENON 810
FISHER 813
JVC 802
PANASONIC 803
KENWOOD 804, 807
ONKYO 808, 809
SONY 801, 806
TEAC 805
YAMAHA 811, 812
PIONEER 800

CD

Manufacturer Code

DENON 309
JVC 303
PANASONIC 304, 326
KENWOOD 310, 311, 321
MARANTZ 323
ONKYO 307, 308, 320
PHILIPS 312, 313, 322
RCA 302, 319
SONY 301, 316, 317, 318
TEAC 305, 306, 324, 325,
 327
YAMAHA 314, 315, 328
PIONEER 300

CD-R

Manufacturer Code

PHILIPS 346
PIONEER 345
YAMAHA 347

MD

Manufacturer Code

SONY 901
KENWOOD 903
SHARP 902
TEAC 904
ONKYO 905
DENON 906
PIONEER 900

DAT

Manufacturer Code

PIONEER 907

Chapter 11:

Additional information**Troubleshooting**

Incorrect operations are often mistaken for trouble and malfunctions. If you think that there is something wrong with this component, check the points below. Sometimes the trouble may lie in another component. Investigate the other components and electrical appliances being used. If the trouble cannot be rectified even after exercising the checks listed below, ask your nearest Pioneer authorized service center or your dealer to carry out repair work.

- If the unit does not operate normally due to external effects such as static electricity disconnect the power plug from the outlet and insert again to return to normal operating conditions.

Problem	Remedy
The power does not turn on.	<ul style="list-style-type: none"> • Disconnect the power plug from the outlet, and insert again. • Make sure there are no loose strands of speaker wire touching the rear panel. This could cause the receiver to shut off automatically. • If the power shuts off automatically, take the unit to your nearest Pioneer authorized service center or your dealer for servicing. • The unit may have been switched on using the wrong voltage setting. Make sure you switch the VOLTAGE SELECTOR on the rear panel to the right voltage for your country or region, then reset the unit (page 52) before switching on again.
No sound is output when a function is selected.	<ul style="list-style-type: none"> • Make sure the component is connected correctly (refer to <i>Connecting up</i> on page 11). • Press MUTE on the remote control to turn muting off.
No image is output when a function is selected.	<ul style="list-style-type: none"> • Make sure the component is connected correctly (refer to <i>Connecting up</i> on page 11). • Select the correct component (use the input select buttons).
Considerable noise in radio broadcasts.	<ul style="list-style-type: none"> • Connect the antenna (page 16) and adjust the position for best reception. • Route any loose cables away from the antenna terminals and wires. • Fully extend the FM wire antenna, position for best reception, and secure to a wall (or connect an outdoor FM antenna). • Connect an additional internal or external AM antenna (page 16). • Turn off equipment causing interference or move it away from the receiver (or move antennas farther away from equipment causing noise).
Broadcast stations cannot be selected automatically.	<ul style="list-style-type: none"> • Connect an outdoor antenna (refer to page 16).

Problem	Remedy
No sound from surround or center speakers.	<ul style="list-style-type: none"> • Connect the speakers properly (refer to page 17). • Refer to <i>Speaker setting</i> on page 38 to check the speaker settings. • Refer to <i>Channel level</i> on page 39 to check the speaker levels.
No sound from surround back speaker (<i>VSX-516 model only</i>).	<ul style="list-style-type: none"> • Refer to <i>Speaker setting</i> on page 38 to check the surround back speaker settings. • Refer to <i>Channel level</i> on page 39 to check the speaker levels. • Refer to <i>Using surround back channel processing</i> on page 31 to make sure surround back channel processing and the sound mode are set for surround back sound.
No sound from subwoofer.	<ul style="list-style-type: none"> • Make sure the subwoofer is switched on. • If the subwoofer has a volume knob, make sure it's turned up. • The Dolby Digital or DTS source you are listening to may not have an LFE channel. • Switch the subwoofer setting in <i>Speaker setting</i> on page 38 to YES or PLUS. • Switch the <i>LFE Attenuator Setup</i> on page 40 to LFEATT 0 or LFEATT 10.
Noise during playback of a cassette deck.	<ul style="list-style-type: none"> • Move the cassette deck further from your receiver, until the noise disappears.
No sound is output or a noise is output when software with DTS is played back.	<ul style="list-style-type: none"> • Set the digital volume level of the player to full, or to the neutral position.
During a playback search, noise is output from a DTS compatible CD player.	<ul style="list-style-type: none"> • This is not a malfunction, but be sure to turn the volume down to prevent the output of loud noise from your speakers.
Can't operate the remote control.	<ul style="list-style-type: none"> • Replace the batteries (refer to page 5). • Operate within 7 m, 30° of the remote sensor on the front panel (refer to page 5). • Remove the obstacle or operate from another position. • Avoid exposing the remote sensor on the front panel to direct light.
The display is dark or off.	<ul style="list-style-type: none"> • Press DIMMER on the remote repeatedly to return to the default.

Resetting the main unit

Use this procedure to reset all the receiver's settings to the factory default. Use the front panel controls to do this.

- 1 Switch the receiver into standby.**
- 2 While holding down the TONE button, press and hold the \odot STANDBY/ON button for about three seconds.**
- 3 When you see RESET? appear in the display, press the ENTER button.**
OK? shows in the display.
- 4 Press SETUP to confirm.**
OK appears in the display to indicate that the receiver has been reset to the factory default settings.

Switching the speaker impedance

We recommend using speakers of 8 Ω with this system, but it is possible to switch the impedance setting if you plan to use speakers with a 6 Ω impedance rating.

- **With the receiver in standby, press the SPEAKER IMPEDANCE button.**

Each time you do this, you switch between the impedance settings:

- **SP 6 OHM** – Use this setting if your speakers are rated at 6 Ω .
- **SP 8 OHM** – Use this setting if your speakers are rated at 8 Ω or more.

Power cord caution

Handle the power cord by the plug. Do not pull out the plug by tugging the cord and never touch the power cord when your hands are wet as this could cause a short circuit or an electric shock. Do not place the unit, a piece of furniture, etc., on the power cord, or pinch the cord. Never make a knot in the cord or tie it with other cords. The power cords should be routed such that they are not likely to be stepped on. A damaged power cord can cause a fire or give you an electrical shock. Check the power cord once in a while. When you find it damaged, ask your nearest Pioneer authorized service center or your dealer for a replacement.

Additional information

Specifications

Amplifier section

- **Continuous power output (stereo)**
Front 100 W (DIN 1 kHz, THD 1.0 %, 8 Ω)
- **Maximum Power output (surround)**
Front
. 130 W per channel (1 kHz, THD 10 %, 8 Ω)
Center 130 W (1 kHz, THD 10 %, 8 Ω)
Surround 130 W per channel
(1 kHz, THD 10 %, 8 Ω)
Surround Back (*VSX-516 model only*)
. 130 W (1 kHz, THD 10 %, 8 Ω)

Audio section

- **Input (Sensitivity/Impedance)**
CD, DVR/VCR, CD-R/TAPE/MD,
DVD/LD, TV/SAT. 200 mV/47 k Ω
- **Frequency response**
CD, DVR/VCR, CD-R/TAPE/MD, DVD/LD,
TV/SAT 5 Hz to 100 000 Hz ± 3 dB
- **Output (Level/Impedance)**
DVR/VCR REC, CD-R/TAPE/
MD REC 200 mV/2.2 k Ω
- **Tone control**
Bass ± 6 dB (100 Hz)
Treble ± 6 dB (10 kHz)
Loudness +10 dB/+5 dB (100 Hz/10 kHz)
(at volume level -50 dB)
- **Signal-to-Noise Ratio DIN (Continuous rated power output / 50 mW)**
CD, DVR/VCR, CD-R/TAPE/MD,
DVD/LD, TV/SAT. 88 dB/64 dB
- **Signal-to-Noise Ratio (IHF, short circuited, A network)**
CD, DVR/VCR, CD-R/TAPE/MD,
DVD/LD, TV/SAT. 96 dB
- **Signal-to-Noise Ratio [EIA, at 1 W (1 kHz)]**
CD, DVR/VCR, CD-R/TAPE/MD,
DVD/LD, TV/SAT. 79 dB

Video Section

- **Input (Sensitivity/Impedance)**
DVR/VCR, DVD/LD, TV/SAT 1 Vp-p/75 Ω
- **Output (Level/Impedance)**
DVR/VCR, MONITOR OUT 1 Vp-p/75 Ω
- **Frequency response**
DVR/VCR, DVD/LD,
TV/SAT \Leftrightarrow MONITOR 5 Hz to 7 MHz ± 3 dB
Signal-to-Noise Ratio 55 dB
Crosstalk 50 dB

FM Tuner Section

- Frequency Range 87.5 MHz to 108 MHz
Usable Sensitivity Mono: 13.2 dBf, IHF
(1.3 μ V/75 Ω)
50 dB Quieting Sensitivity Mono: 20.2 dBf
Stereo: 38.6 dBf
Signal-to-Noise Ratio . . . Mono: 73 dB (at 85 dBf)
Stereo: 70 dB (at 85 dBf)
Distortion. Stereo: 0.5 % (1 kHz)
Alternate Channel Selectivity . . . 60 dB (400 kHz)
Stereo Separation. 40 dB (1 kHz)
Frequency Response 30 Hz to 15 kHz
(± 1 dB)
Antenna Input (DIN). 75 Ω unbalanced

AM Tuner Section

- Frequency Range
9 kHz step 531 kHz to 1602 kHz
10 kHz step 530 kHz to 1700 kHz
Sensitivity (IHF, Loop antenna) 350 μ V/m
Signal-to-Noise Ratio 50 dB
Antenna. Loop antenna

Miscellaneous

- Power requirements
Black model. AC 110 V/AC 120 V to 127 V/
AC 220 V/AC 240 V, 50 Hz/60 Hz
Silver model
Australia model. AC 240 V, 50 Hz
All other models . . . AC 110 V/AC 120 V to 127 V/
AC 220 V/AC 240 V, 50 Hz/60 Hz
Power consumption
VSX-416 280 W
VSX-516 320 W
In standby 0.5 W (AC 220 V/50 Hz)

Dimensions

VSX-416

..... 420 (W) mm x 158 (H) mm x 348 (D) mm

VSX-516

..... 420 (W) mm x 158 (H) mm x 352.5 (D) mm

Weight (without package)

VSX-416 8.4 kg

VSX-516 8.5 kg

Furnished Parts

VSX-516 model only – Microphone (for Auto

MCACC setup) 1

Dry cell batteries (AA size IEC R6) 2

Remote control 1

AM loop antenna 1

FM wire antenna 1

Power cords:

VSX-416/516-K (black models) 2

(Round 2-pin type and Australian type)

VSX-416/516-S

(silver models - Except Australian model) ... 3

(Round 2-pin type, flat blade 2-pin type,

UK 3-pin type)

Power plug adaptor (*VSX-416/516-K only*) 1

J-shaped plug 1

These operating instructions

Manufactured under license from Dolby Laboratories. "Dolby", "Pro Logic", "Surround EX", and the double-D symbol are trademarks of Dolby Laboratories.

"DTS", "DTS-ES Extended Surround" and "Neo:6" are trademarks of Digital Theater Systems, Inc.

**Note**

- Specifications and the design are subject to possible modifications without notice, due to improvements.

Cleaning the unit

- Use a polishing cloth or dry cloth to wipe off dust and dirt.
- When the surface is dirty, wipe with a soft cloth dipped in some neutral cleanser diluted five or six times with water, and wrung out well, and then wipe again with a dry cloth. Do not use furniture wax or cleansers.
- Never use thinners, benzine, insecticide sprays or other chemicals on or near this unit, since these will corrode the surface.

Published by Pioneer Corporation.
Copyright © 2006 Pioneer Corporation.
All rights reserved.

PIONEER CORPORATION

4-1, Meguro 1-Chome, Meguro-ku, Tokyo 153-8654, Japan

PIONEER ELECTRONICS (USA) INC.

P.O. BOX 1540, Long Beach, California 90810-1540, U.S.A. TEL: (800) 421-1404

PIONEER ELECTRONICS OF CANADA, INC.

300 Allstate Parkway, Markham, Ontario L3R OP2, Canada TEL: 1-877-283-5901

PIONEER EUROPE NV

Haven 1087, Keetberglaan 1, B-9120 Melsele, Belgium TEL: 03/570.05.11

PIONEER ELECTRONICS ASIACENTRE PTE. LTD.

253 Alexandra Road, #04-01, Singapore 159936 TEL: 65-6472-7555

PIONEER ELECTRONICS AUSTRALIA PTY. LTD.

178-184 Boundary Road, Braeside, Victoria 3195, Australia, TEL: (03) 9586-6300

PIONEER ELECTRONICS DE MEXICO S.A. DE C.V.

Blvd.Manuel Avila Camacho 138 10 piso Col.Lomas de Chapultepec, Mexico,D.F. 11000 TEL: 55-9178-4270

K002_A_En